

# DA11ARC

## Quick Reference Guide

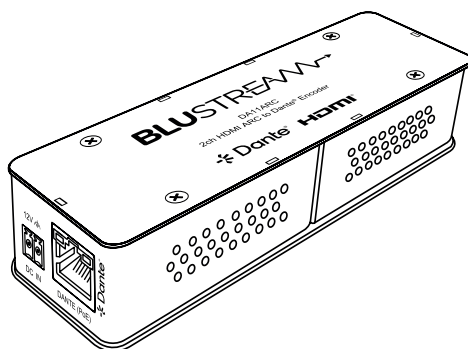

## Introduction

Our DA11ARC has been designed to encode HDMI ARC (Audio Return Channel) 2ch audio to a Dante® digital signal. The DA11ARC is a plug & play device that is powered using PoE (Power Over Ethernet). The DA11ARC also supports AES67 RTP audio transport.

### FEATURES:

- Encodes HDMI ARC (Audio Return Channel) 2ch audio to a Dante® digital signal
- Supports: 44.1, 48, & 96kHz sample rates @ 24 Bit
- Configurable Dante® device latency (supports 2, 3, 4, 5 or 10ms configurable using Dante® Controller)
- Input sensitivity/volume control adjustable via CEC, web GUI or API
- Supports AES67 RTP audio transport
- Features Class 0 802.3af PoE for powering of product from any PoE switch
- Local 12v power supply input for when network switch does not support PoE\*

\* PS121PH power supply sold separately

### Front Panel

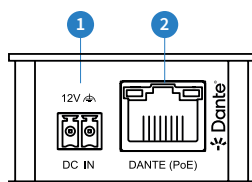

### Rear Panel

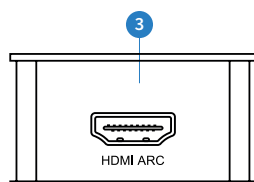

### Side Panel

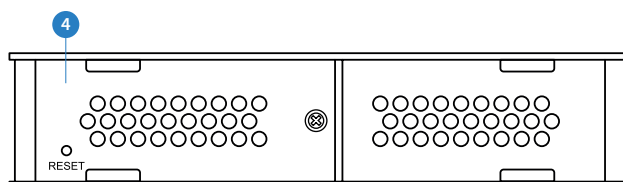

### Connections:

- 1 DC Input - Connect to +12VDC power supply (not supplied) if device is not powered via a PoE switch
- 2 Dante® Audio Input/Output - RJ45 socket connects Dante® network and powers device via PoE
- 3 HDMI ARC Audio Input - HDMI output connector connects to displays ARC HDMI Input®
- 4 Reset Switch - Press and hold to reset device

# Dante Controller

Dante Controller software is required in order to setup and configure the DA11ARC as well as control your Dante network. Audinate provide extensive training videos and documentation on their website. This can be found here: <http://www.audinate.com/products/software/dante-controller>

Upon connecting your DA11ARC to a compatible network, the Dante Controller software should automatically discover the device. The DA11ARC will appear in the Dante Controller with a name denoted with "DA11ARC". On the "Routing" screen you can create audio routing between Dante transmitters and receivers in your system.

Please ensure your PC is on the same network as your Dante devices. Dante is not able to transmit over WiFi and it is recommended to hardwire into the Dante network. Having multiple network devices enabled can also confuse the Dante Controller software so it is recommended to disable WiFi during configuration.

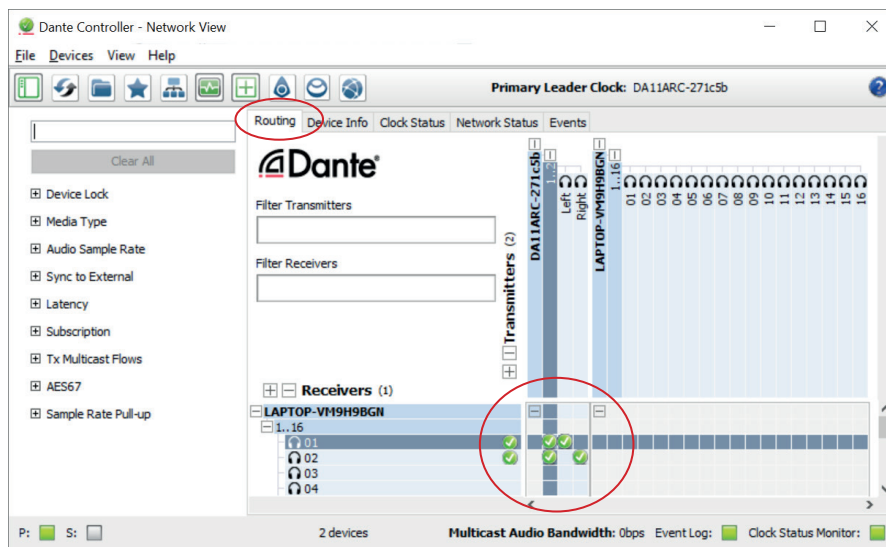

It is also possible to change the settings of the DA11ARC under the "Device Info" screen in the Dante Controller software. To do so, select the "Device Config" menu.

Here we can adjust the sample rate and the encoding bit rate of the DA11ARC. Please note that Dante products can only transmit or receive audio from other Dante products that are set up with the same sample rate. A mismatch in sample rate may stop audio from transmitting.

Under the "Device Config" screen we can also adjust the latency of the DA11ARC from 2, 3, 4, 5 or 10 milliseconds.

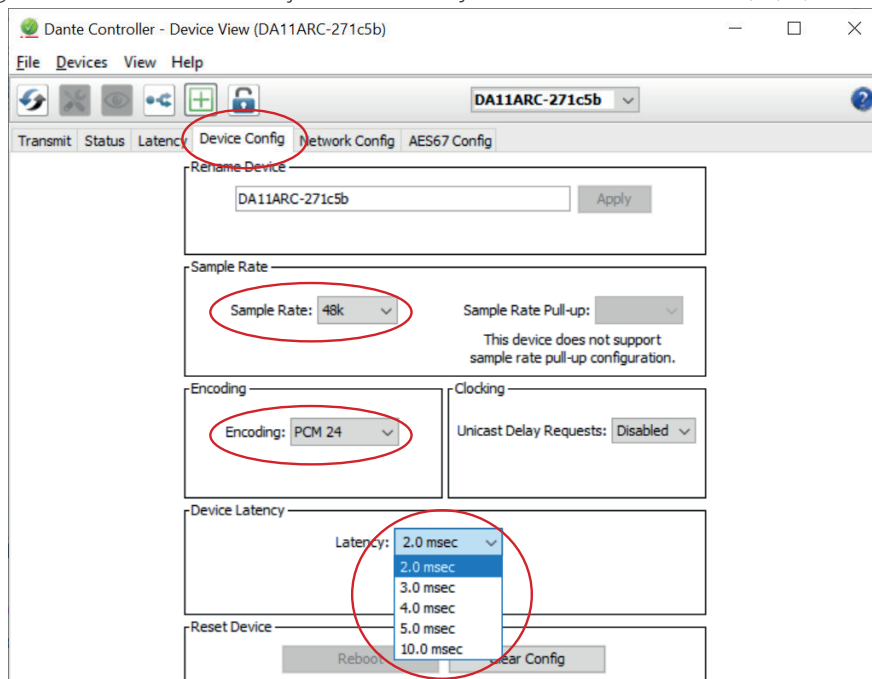

# Web Interface Module

The DA11ARC features an in-built Web GUI which can be used for control and configuration of the device. By default the device is set to DHCP, however if a DHCP server (eg: network router) is not installed the device will receive a link local address in the 169.254.xxx.xxx range. The device info screen of Dante Controller will provide you with the IP address information of each unit.

Device Name	Model Name	Product Version	Dante Version	Device Lock	Primary Address	Primary Link Speed	Secondary Address	Secondary Link Speed
DA11ARC-271c5b	DA11ARC	1.0.1	1.3.1.1	<input type="checkbox"/>	169.254.65.93	100Mbps	N/A	N/A
LAPTOP-VM9H9BGN	Dante Virtual Soundcard	4.4.1.3	4.4.1.3	<input type="checkbox"/>	169.254.0.222	100Mbps	N/A	N/A

By accessing the IP address of the DA11ARC in your web browser, you will gain access to the units web GUI. The following details will allow you to log in to the admin section:

Default **Username** is: [blustream](#)      Default **Password** is: [1234](#)

This will provide access to change the network settings to meet your systems requirements.

## Settings Page:

**BLUSTREAM**
**Settings**

Control
Users
Settings
System
Information
Update Password
Log Out

### IP Setting

IP Mode: Static DHCP

IP Address:

Subnet:

TCP Port:   Enable

Gateway:

Telnet Port:   Enable

Domain Name:  .local

### Product Model Setting

Product Model:

Set Network Defaults
Save

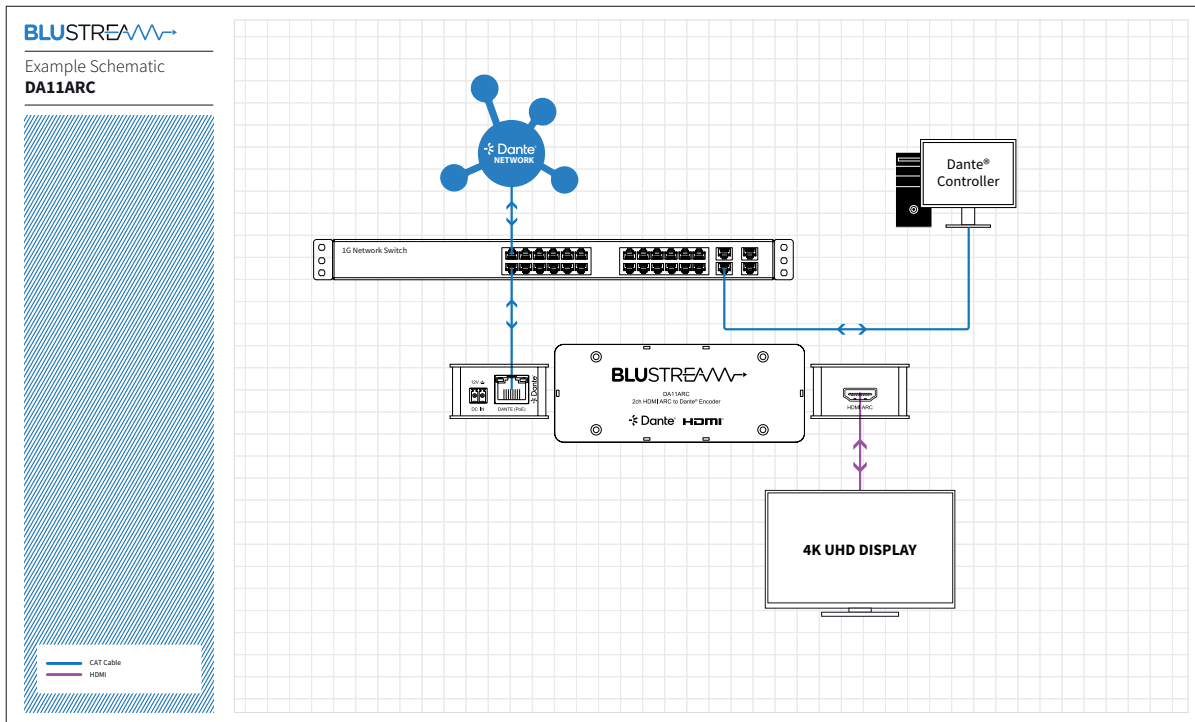

## Specifications

- Audio Output Connector:** 1 x RJ45, female (100 Mbps Dante® network)
- Audio Input Connector:** 1 x HDMI, female (2ch ARC audio only)
- Casing Dimensions (L x W x H):** 120mm x 47mm x 26mm
- Shipping Weight:** 0.3 Kg
- Operating Temperature:** 32°F to 104°F (0°C to 40°C)
- Storage Temperature:** - 4°F to 140°F (- 20°C to 60°C)
- Power Supply:** Class 0 IEEE 802.3af POE PD or 12V/1A DC 2-pin Phoenix connector

## Package Contents

- 1 x DA11ARC
- 1 x Quick Reference Guide

## Acknowledgements

Dante® is a registered trademark of Audinate Pty Ltd.

## Certifications

### FCC NOTICE

This equipment has been tested and found to comply with the limits for a Class B digital device, pursuant to part 15 of the FCC Rules. These limits are designed to provide reasonable protection against harmful interference in a residential installation. This equipment generates, uses, and can radiate radio frequency energy and, if not installed and used in accordance with the instructions, may cause harmful interference to radio communications. However, there is no guarantee that interference will not occur in a particular installation. If this equipment does cause harmful interference to radio or television reception, which can be determined by turning the equipment off and on, the user is encouraged to try to correct the interference by one or more of the following measures:

- Reorient or relocate the receiving antenna.
- Increase the separation between the equipment and receiver.
- Connect the equipment into an outlet on a circuit different from that to which the receiver is connected.
- Consult the dealer or an experienced radio/TV technician for help.

**CAUTION** - changes or modifications not expressly approved by the party responsible for compliance could void the user’s authority to operate the equipment.

### CANADA, INDUSTRY CANADA (IC) NOTICES

This Class B digital apparatus complies with Canadian ICES-003. Operation is subject to the following two conditions: (1) this device may not cause interference, and (2) this device must accept any interference, including interference that may cause undesired operation of the device.

### CORRECT DISPOSAL OF THIS PRODUCT

This marking indicates that this product should not be disposed with other household wastes. To prevent possible harm to the environment or human health from uncontrolled waste disposal, recycle it responsibly to promote the sustainable reuse of material resources. To return your used device, please use the return and collection systems or contact the retailer where the product was purchased. They can take this product for environmentally safe recycling.