

Activating Dante Ready

Dante Ready implementation on K-array devices

USER GUIDE



•20230515•

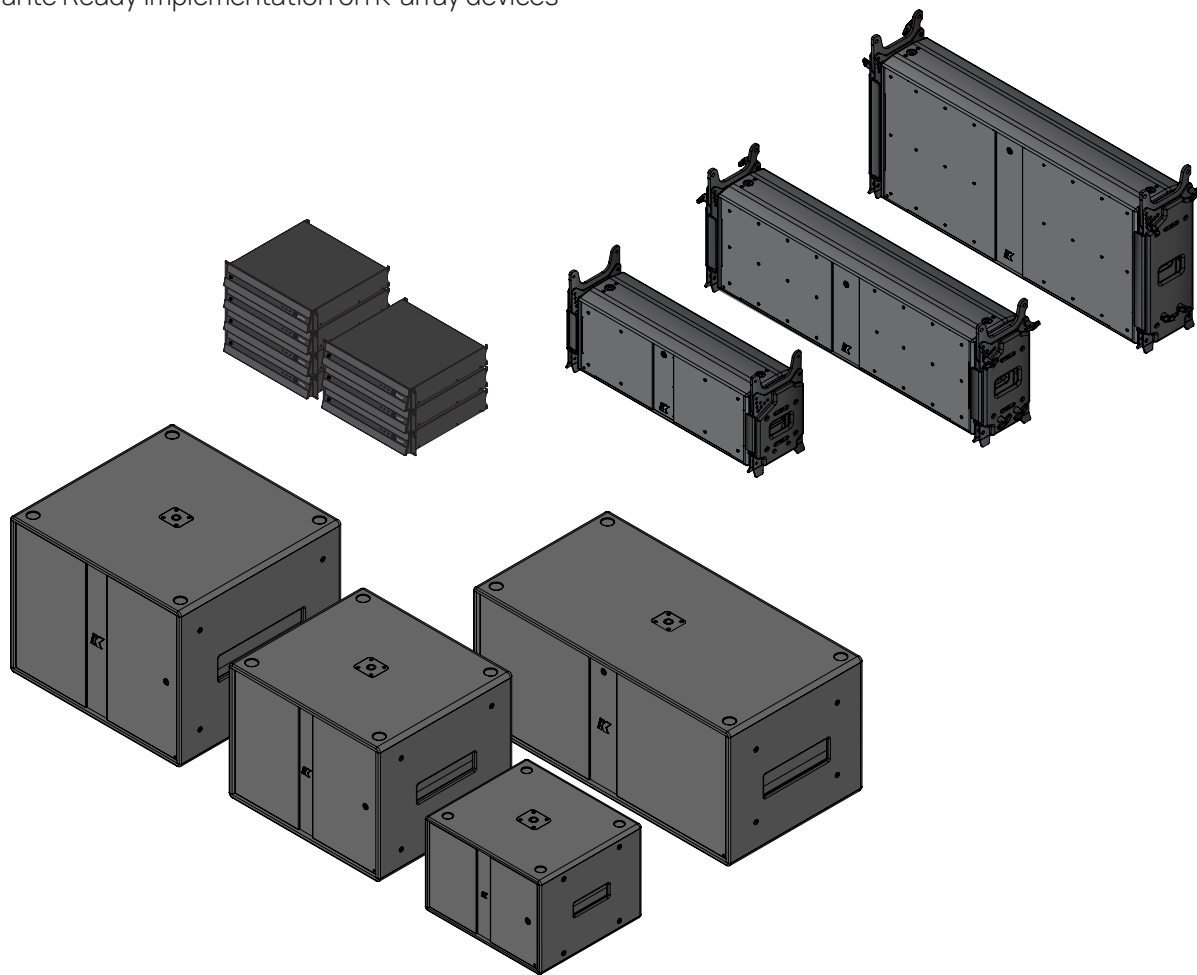

Dante Ready™



Integrated
Electronic
Brain

K-ARRAY
Unique Audio Solutions

Activating Dante Ready

User Guide

Thank you for choosing this K-array products!

To ensure proper operation, please carefully read the owner's manuals and safety instruction before using the products.

After reading this manual, be sure to keep it for future reference.

Dante is a proprietary digital media networking solution, developed by Audinate and licensed by K-array, which allows to convey audio content over standard Ethernet networks using the Internet Protocol (Audio over IP).

When a K-array device receives Dante audio packets, it reconstructs them back into a continuous digital audio stream, which is then played out. The Dante audio implementation is 100% lossless 24- or 32-bit PCM, 48 kHz sample rate.

K-array devices incorporate Dante as an optional software implemented solution, giving the user to get immediate, no-fuss connectivity over IP on demand.

Dante Ready

Dante Ready allows the user to purchase and add audio channels to a K-array device after initial purchase with easy-to-use software, paying only for as many channels as are required.

Dante Controller

Dante Controller software allows the user to configure signal routes and other settings. All routes and settings are stored in the individual Dante devices, allowing them to run without any connected computers.

Dante Ready Activator scans the local Dante network for any Dante Ready eligible products and shows the available options; purchases are immediately applied to the target devices for a smooth, easy experience.

In order to add channels to a K-array Dante Ready device, Dante Controller must be updated to version 4.5.0.9 or later (February 2022) which includes Dante Ready Activator.

Integrated Electronic Brain

K-array active devices integrates a new generation intelligence software, named osKar, that allows the user to manage the entire system through various control platforms.

With a real quad-core computer and embedded DSP featuring oskar, K-array devices offer enhanced signal processing and managing experience called IEB – Integrated Electronic Brain –giving the user control over the system performance.

In order to add channels to a K-array Dante Ready device, osKar must be updated to OS version 1.3.4 or later.

K-array Dante Embedded Platforms

K-array devices embedding Dante Ready born with no active Dante channels and can be upgraded to 2 IN x 2 OUT Dante channels (Ships with 0x0 / Upgradeable to 2x2).

Customers can make channel purchases directly within Dante Controller using Audinate's payment system on the following K-array devices and systems:

- Mugello-KH2I
- Mugello-KH3I
- Mugello-KH5I
- Thunder-KS1I
- Thunder-KS2I
- Thunder-KS3I
- Thunder-KS4I
- Thunder-KS5I
- Kommander-KA02I
- Kommander-KA04
- Kommander-KA14I
- Kommander-KA18
- Kommander-KA28
- Kommander-KA34
- Kommander-KA68
- Kommander-KA104
- Kommander-KA208
- Azimut-KAMUT2LII
- Azimut-KAMU2L1I
- Azimut-KAMUT2L14II
- AzimutKAMUT2V25II
- Pinnacle-KR102II
- Pinnacle-KR202II
- Pinnacle-KR204II
- Pinnacle-KR402II
- Pinnacle-KR404II
- Pinnacle-KR802II
- Pinnacle-KR804II

Activating Dante Ready

User Guide

Add Dante Channels To A K-array Device

1. Connect the K-array Dante Embedded Platform to a Dante network.
2. Ensure that an Internet connection is available and accessible.

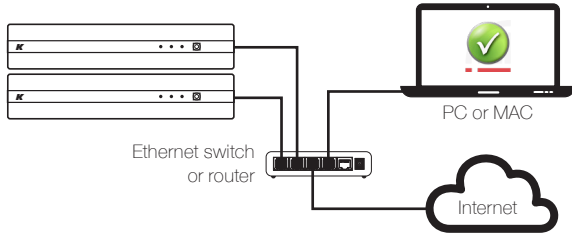

3. Ensure the Dante Controller is updated to version 4.5.0.9 or later (February 2022) which includes Dante Ready Activator.

At the startup the Dante Controller scans the local network for any Dante device: the name of the Dante Embedded Platform – DEP – with no available channels are shown in red.

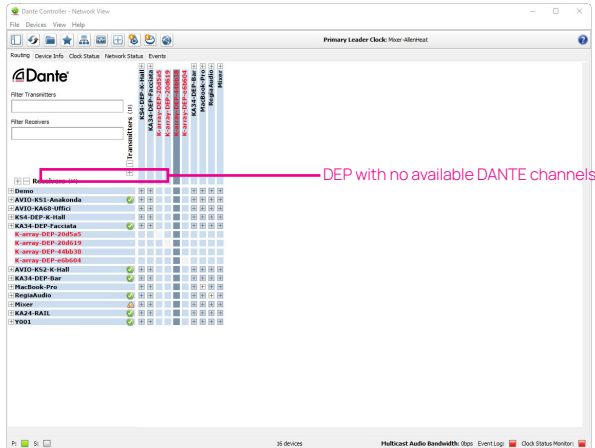

4. In order to add channels to a K-array Dante Ready device click on the Dante Ready Activator button in the toolbar.

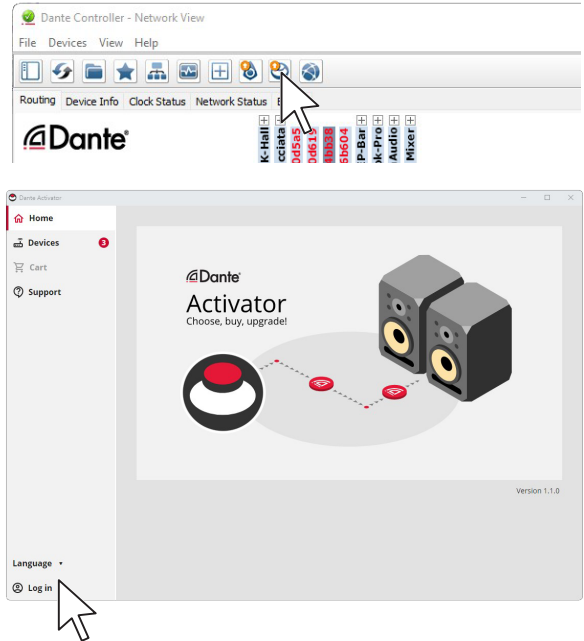

5. Log in using the username and password of your Audinate account.
6. The number of the available Dante Ready devices is shown in a badge on the tab Devices in the sidebar: click to open details.

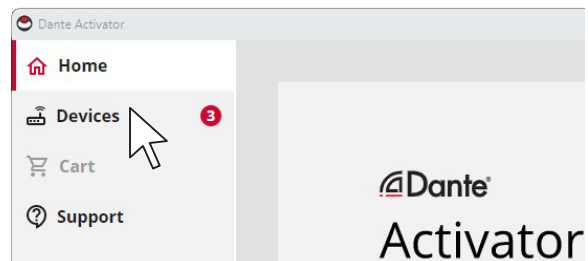

Activating Dante Ready

User Guide

The available Dante Ready devices are grouped in two classes:

- upgradeable devices are Dante Ready products with no active DANTE channels (eligible to be activated) or devices with an old version of the software;
- up-to-date devices have been activated as Dante-enabled products.



The name of the available Dante Ready devices shown on both the Dante Controller and Dante Ready Activator is:

K-array-DEP- <ID number>

In order to match the name given to the Dante Ready device with the actual K-array product, check the IP address on both the Dante Controller and the K-array device web app or K-array Connect app.

7. Focus on the upgradeable Dante Ready devices: click on New Activation to see the Dante Ready devices eligible to be activated.



If the Dante Ready device you want to activate is not shown in the list:

- check the IP connection;
- click on the Scan for Devices button at the bottom of the window.

Language ▾



Scan for Devices

8. Click on the K-array device you want to activate.

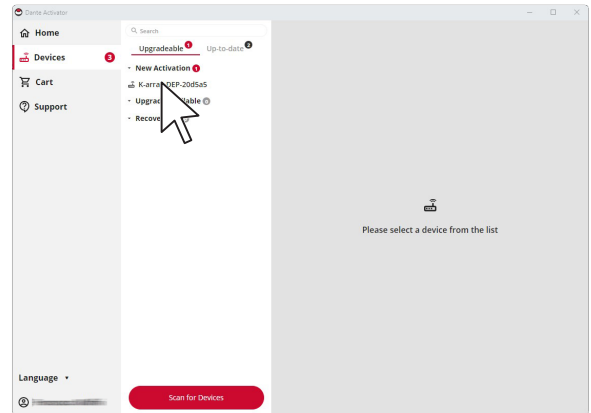

The right panel will show the available channel options that can be activated (i.e. 2x2 AUDIO CHANNELS).

9. Click on the channel option you want to activate.

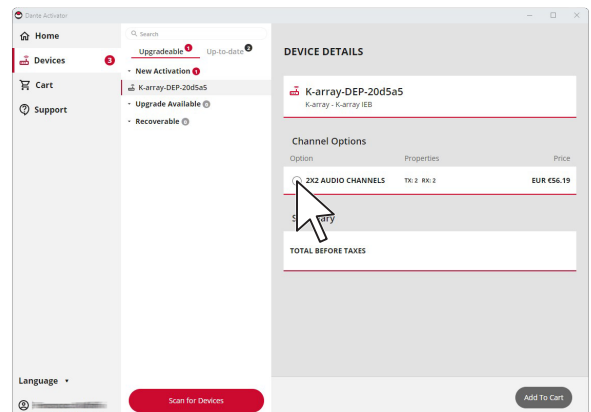

Activating Dante Ready

User Guide

10. Once the desired channel option is checked, proceed to the purchase: click on Add to Cart.

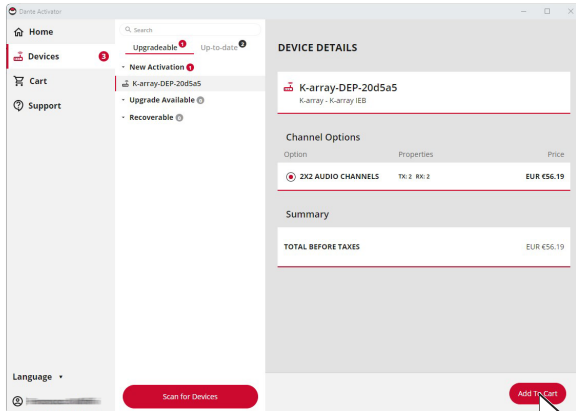

11. You can opt for either a new activation of a further Dante Ready device, or check out for payment.

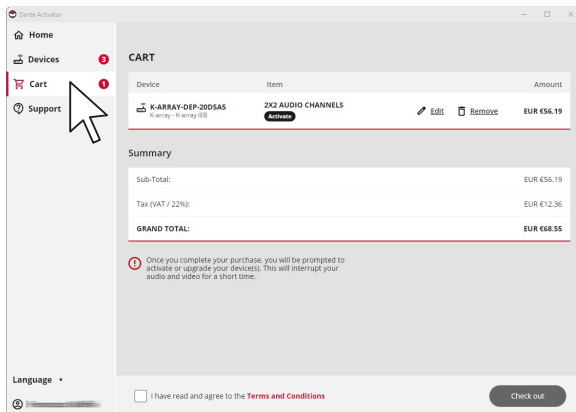

12. When ready, proceed to payment: Audinate will take care of the payment procedure.

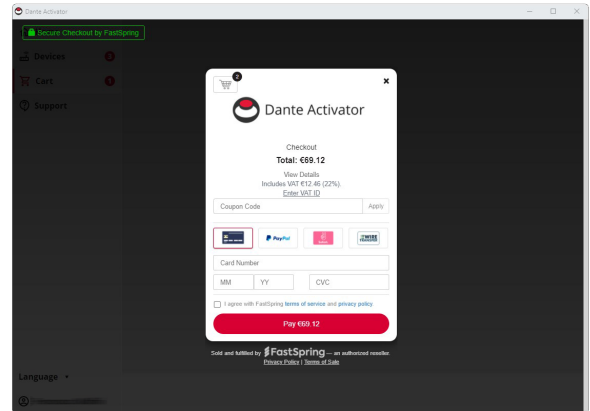

Once activated, the Dante licence for the selected channel option is transferred to the device. The K-array Dante Ready product is now recognized by the Dante Controller as a Dante-enabled products.

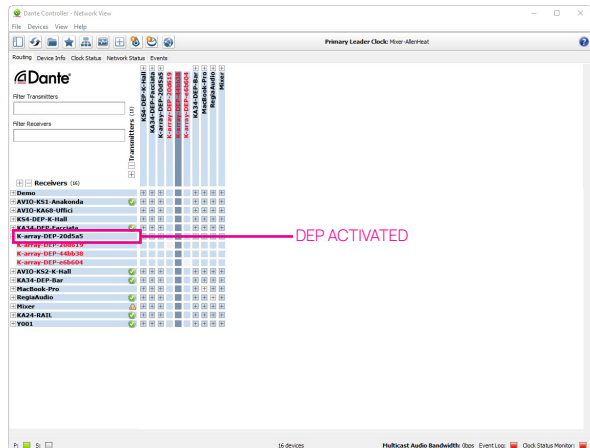

Activating Dante Ready

User Guide

Managing Dante Streams

In order to route the audio stream from the DANTE input channels to the K-array device output channels:

- A. access your K-array device via the K-array Connect app or write the K-array product's IP address on a web browser in your computer.
- B. Access the on-board web app.



Dante Ready input in disable by default (either activated or not).

- C. In order to enable Dante Ready on your K-array device click on the Dante Ready button in the player section.

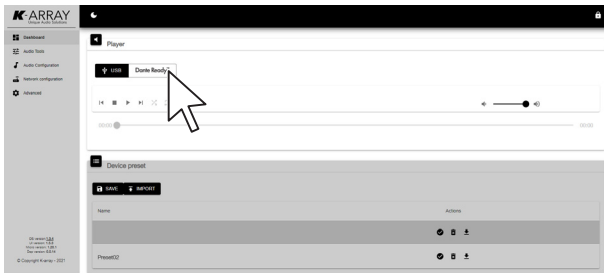

When the Dante Ready is enabled, the USB player is disabled.

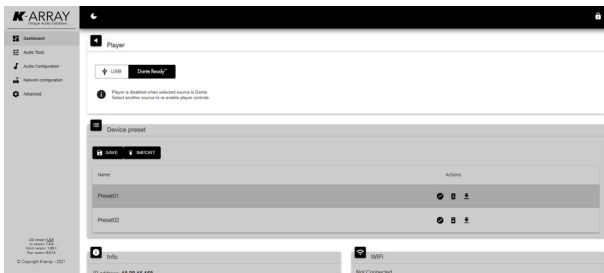

The audio stream from the Dante input channels are available on the latest two input channels of the K-array device (namely, input 3&4 in four channel device, input 7&8 in eight channel device): they barely replace the USB player stream. Set the signal routing according to your need.

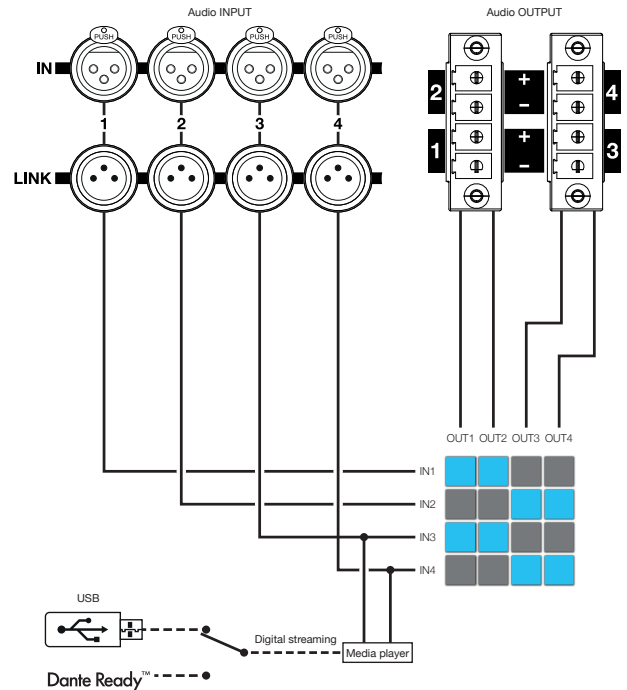

Schema of the signal routing of a 4-channel device.



Designed and Made in Italy

K-ARRAY srl
Via P. Romagnoli 17 | 50038 Scarperia e San Piero - Firenze - Italy
ph +39 055 84 87 222 | info@k-array.com

www.k-array.com