

# ► CMX44CS

## User Manual

## Thank you for purchasing this product.

For optimum performance and safety, please read these instructions carefully before connecting, operating or adjusting this product. Please keep this manual for future reference.



### Surge Protection Device Recommended

This product contains sensitive electrical components that may be damaged by electrical spikes, surges, electric shock, lightning strikes, etc. Use of surge protection systems is highly recommended in order to protect and extend the life of your equipment.

## Contents

Introduction	03
Features	03
Front Panel Description	04
Rear Panel Description	04
EDID Management	05
Infrared (IR) Control	06
Web GUI Control	06-10
Remote Control Description	11
IR Commands	11-12
Specifications	13
Package Contents	13
Maintenance	13
RS-232 Config & Telnet Commands	14-15
Schematic	16
Certifications	17

# Introduction

Our Contractor CMX44CS 4K HDMI Matrix offers unprecedented performance and value for the custom installation market. The CMX44CS supports HDMI2.0 with HDCP2.2, allowing distribution of four HDMI sources to four displays. This enables all sources to be viewed as required within a matrix configuration. The unit transmits all HDMI resolutions up to and including 4K 60Hz 4:4:4 with automatic video down conversion. The 4-way matrix also includes audio breakout and advanced EDID management.

---

## FEATURES:

---

- Features 4x HDMI inputs which can be independently routed to 4x HDMI outputs
- Supports HDMI2.0 18Gbps specification including HDR
- Supports up to 4K UHD 60Hz 4:4:4
- Video down-conversion on outputs allowing a display only capable of supporting lower video resolutions (4K 60Hz 4:2:0 or 1080p) to receive 4K 60Hz 4:4:4 video content while still showing maximum original 4K UHD resolution on remaining video outputs
- Supports all industry standard video resolutions including VGA-WUXGA and 480i-4K
- Supports all known HDMI audio formats including Dolby Atmos, Dolby TrueHD, Dolby Digital Plus and DTS-HD Master Audio transmission
- HDMI audio breakout to associated output analogue L/R audio and coaxial digital outputs concurrently
- Control via front panel, IR, RS-232, TCP/IP and Web GUI
- IR routing
- Supplied with Blustream 5V IR receivers and emitters
- 3rd party drivers available for major control brands
- Advanced EDID management
- HDCP2.2 compliant
- 1U Design for 19" rack mount integration - mounting kit included

# Front Panel Description

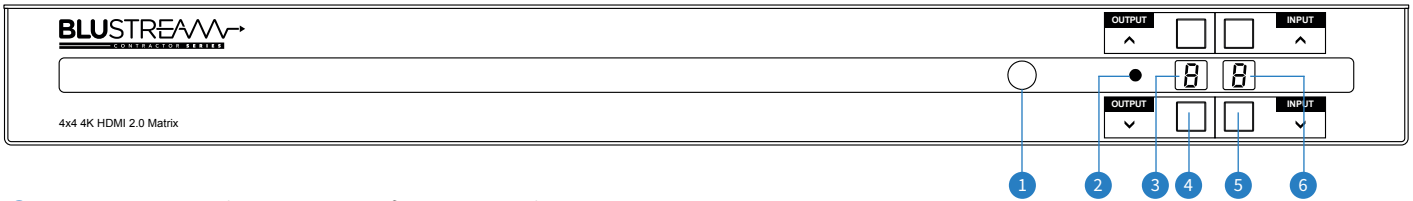

- 1 IR Receiver - Built in IR sensor for IR control
- 2 Status LED - Illuminates blue when matrix is in standby mode and flashes when IR command is received
- 3 Output LCD - Shows the currently selected output
- 4 Output Up / Down Button - Press to adjust the selected output up or down  
Press and hold Output Up button for PTP mode (In 1 to Out 1, In 2 to Out 2, In 3 to Out 4, In 4 to Out 4)
- 5 Input Up / Down Button - Press to adjust the selected input up or down  
Press and hold Input Up button for 3 seconds to power the matrix off
- 6 Input LCD - Shows the currently selected input

# Rear Panel Description

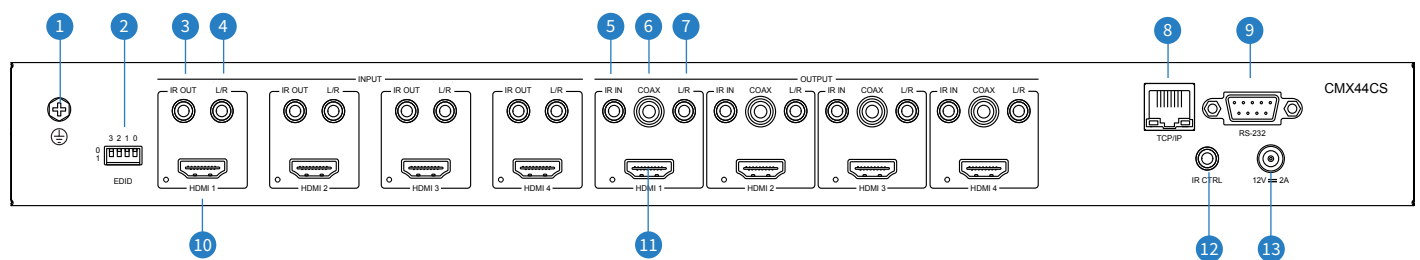

- 1 Ground Screw - Chassis ground connection
- 2 EDID DIP switch – Used for global EDID settings
- 3 IR Emitter Output - 3.5mm mono connector to connect to Blustream IR emitter. Used for local source control
- 4 Analogue L/R Audio Input - 3.5mm stereo connector allows audio to be embedded over HDMI input signal
- 5 IR Receiver Input - 3.5mm stereo connector to connect to Blustream IR receiver or 3rd party control processor
- 6 Coaxial Digital Audio Output - RCA (S/PDIF)
- 7 Analogue L/R Audio Output - 3.5mm stereo connector with fixed line level output. Supports 2 channel PCM audio formats only
- 8 TCP/IP - RJ45 connector for TCP/IP and web-GUI control of the matrix
- 9 RS-232 - DB9 connector for RS-232 control of the matrix
- 10 HDMI Inputs - Connect to source devices
- 11 HDMI Outputs - Connect to display devices
- 12 IR Control Input - 3.5mm stereo connector to connect to Blustream IR receiver for IR control of the matrix
- 13 Power Port - Use included 12V/2A DC power adaptor

## EDID Control

EDID (Extended Display Identification Data) is a data structure that is used between a display and a source. This data is used by the source to find out what audio and video resolutions are supported by the display. By pre-determining the video resolution and audio format of the source and display device you can reduce the time needed for EDID hand shaking thus making switching quicker and more reliable.

Configuration of Matrix EDID settings can be achieved in one of four ways:

- 1 Using Matrix web browser interface (see section on Web GUI Control)
- 2 Using API commands via RS-232 or Telnet (see below)
- 3 Using Matrix EDID dipswitches (see below)

### To configure the EDID via RS-232/Telnet API:

Configuration of the EDID settings for each input can be achieved using the following API commands to specify the required EDID. Please see the section on RS-232 and Telnet API at the end of this manual for connectivity information:

```
EDID xx DF zz Set Input xx EDID To Default EDID zz
  xx = Input On Product (00 Refers To ALL Inputs, 02 = Input 2 Etc)
  zz=00: HDMI 1080p@60Hz, Audio 2ch PCM
  zz=01: HDMI 1080p@60Hz, Audio 5.1ch DTS/DOLBY
  zz=02: HDMI 1080p@60Hz, Audio 7.1ch DTS/DOLBY/HD
  zz=03: HDMI 1080i@60Hz, Audio 2ch PCM
  zz=04: HDMI 1080i@60Hz, Audio 5.1ch DTS/DOLBY
  zz=05: HDMI 1080i@60Hz, Audio 7.1ch DTS/DOLBY/HD
  zz=06: HDMI 1080p@60Hz/3D, Audio 2ch PCM
  zz=07: HDMI 1080p@60Hz/3D, Audio 5.1ch DTS/DOLBY
  zz=08: HDMI 1080p@60Hz/3D, Audio 7.1ch DTS/DOLBY/HD
  zz=09: HDMI 4K@30Hz 4:4:4, Audio 2ch PCM
  zz=10: HDMI 4K@30Hz 4:4:4, Audio 5.1ch DTS/DOLBY
  zz=11: HDMI 4K@30Hz 4:4:4, Audio 7.1ch DTS/DOLBY/HD
  zz=12: DVI 1280x1024@60Hz, Audio None
  zz=13: DVI 1920x1080@60Hz, Audio None
  zz=14: DVI 1920x1200@60Hz, Audio None
  zz=15: User EDID 1
  zz=16: User EDID 2
  zz=17: GUI Download EDID
  zz=18: HDMI 4K@60Hz 4:2:0, Audio 2ch PCM
  zz=19: HDMI 4K@60Hz 4:2:0, Audio 5.1ch DTS/DOLBY
  zz=20: HDMI 4K@60Hz 4:2:0, Audio 7.1ch DTS/DOLBY/HD
  zz=21: HDMI 4K@60Hz 4:4:4, Audio 2ch PCM
  zz=22: HDMI 4K@60Hz 4:4:4, Audio 5.1ch DTS/DOLBY
  zz=23: HDMI 4K@60Hz 4:4:4, Audio 7.1ch DTS/DOLBY/HD
```

### To configure the EDID via DIP Switch:

To configure the global EDID for all inputs via the DIP switch, use the settings below. Note this will override and disallow any EDID settings configured via the web GUI.

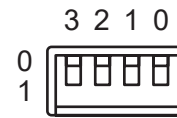

EDID

3	2	1	0	EDID Type
Combination of DIP positions				
0	0	0	0	1080p 60Hz 2.0ch
0	0	0	1	1080p 60Hz 5.1ch
0	0	1	0	1080p 60Hz 7.1ch
0	0	1	1	1080i 60Hz 2.0ch
0	1	0	0	1080i 60Hz 5.1ch
0	1	0	1	1080i 60Hz 7.1ch
0	1	1	0	4K 60Hz 4:2:0 2.0ch
0	1	1	1	4K 60Hz 4:2:0 5.1ch
1	0	0	0	4K 60Hz 4:2:0 7.1ch
1	0	0	1	4K 60Hz 4:4:4 2.0ch
1	0	1	0	4K 60Hz 4:4:4 5.1ch
1	0	1	1	4K 60Hz 4:4:4 7.1ch
1	1	0	0	DVI 1280x1024@60Hz
1	1	0	1	DVI 1920x1080@60Hz
1	1	1	0	DVI 1920x1200@60Hz
1	1	1	1	Software EDID

## Infrared (IR) Control

The Blustream range of matrix products include Matrix control via IR.

**IMPORTANT: Blustream Infrared products are all 5V and NOT compatible with alternative manufacturers Infrared solutions. When using third party 12V IR control solutions please use the Blustream IRCAB cable for IR conversion.**

### IR Receiver - IRR

Blustream 5V IR receiver to receive an IR signal for control of the matrix.

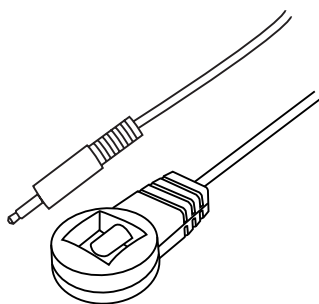

### IR Receiver - Stereo 3.5mm

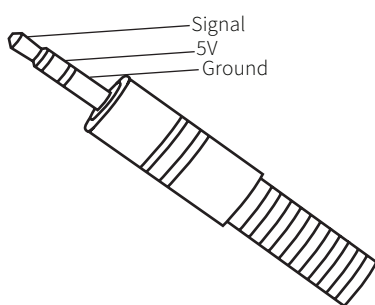

### IR Control Cable - IRCAB

Blustream IR Control cable 3.5mm Mono to 3.5mm Stereo for linking third party control solutions to Blustream products.

Compatible with 12V IR 3rd party products.

**Please Note:** cable is directional as indicated.

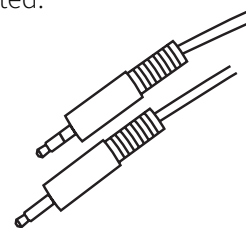

## Web-GUI Control

This following pages take you through the operation of this Matrix's Web-GUI. You must connect the TCP/IP RJ45 socket to your local network in order to access the products Web-GUI.

By default the matrix is set to DHCP, however if a DHCP server (eg: network router) is not installed the matrix IP address will revert to below details:

Default IP Address is: [192.168.0.200](http://192.168.0.200)

Default Username is: [blustream](#)

Default Password is: [1234](#)

The device can also be accessed via its mDNS name which is defaulted to: <http://cmx44cs.local/>

The Web-GUI supports multiple users along with multiple user permissions as follows:

**Guest Account** - This account does not require a user to login. The Guest account can only change sources for each zone. Guest access can be changed by the Admin, limiting inputs or outputs as necessary.

**User Accounts** - User accounts can be utilised, each with individual login details. User accounts can be assigned permissions to specific areas and functions. A User must log in to make use of these functions.

**Admin Account** - This account allows full access to all functions of the Matrix as well as assigning users with permissions.

## Login Page

The Login Page allows a user or admin to login and access additional functionality within the Web GUI.

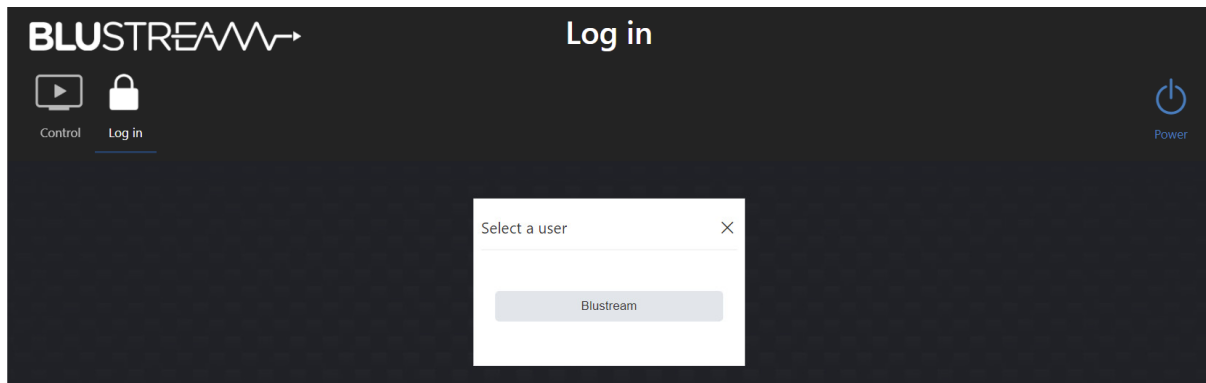

Once you select a user from the list you will be asked to enter the password for that user in order to sign in.

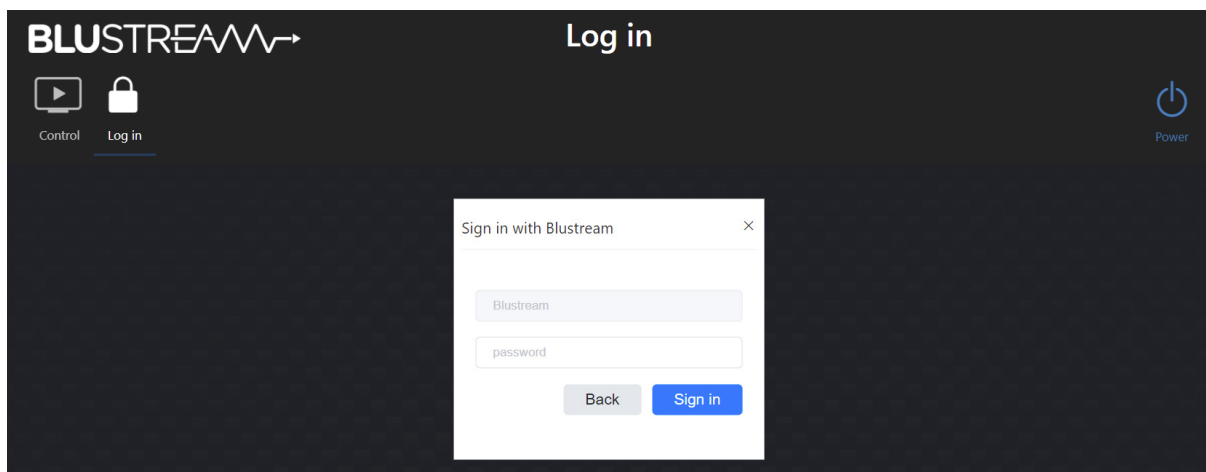

Please note the first time you log in to the web GUI you will be asked to change the default admin password. It is important to record this password as there is no way to recover it in the event that it is forgotten.

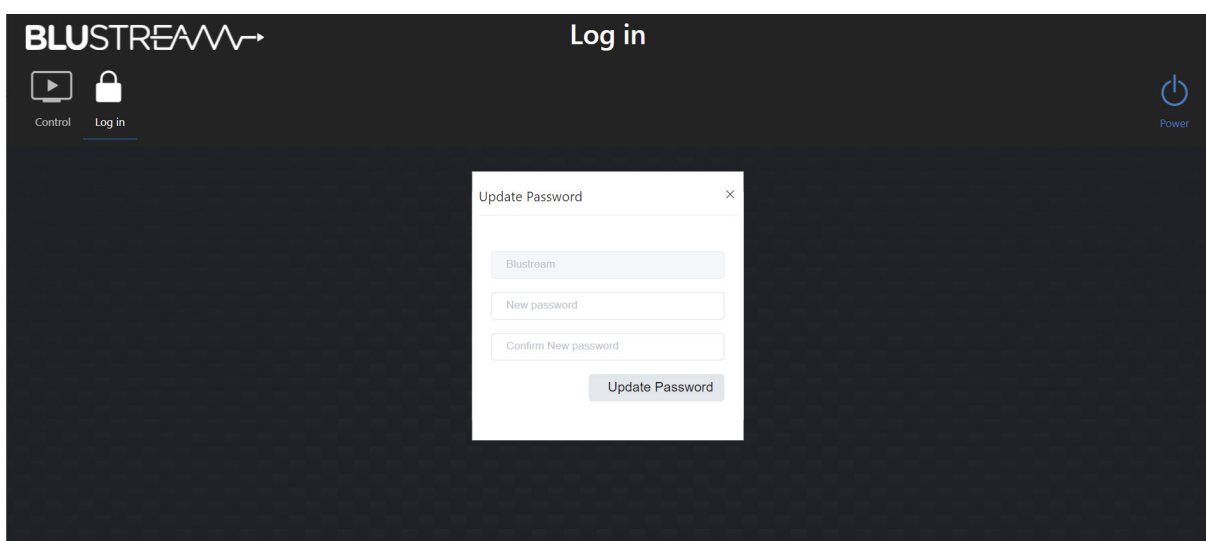

### Guest Control Page

The Guest Control Page allows a guest to change inputs for each zone without needing to be logged into the matrix. Simply select the square that corresponds with the input and zone you wish to change.

There is also a power button on the top right corner to turn the Matrix on or off.

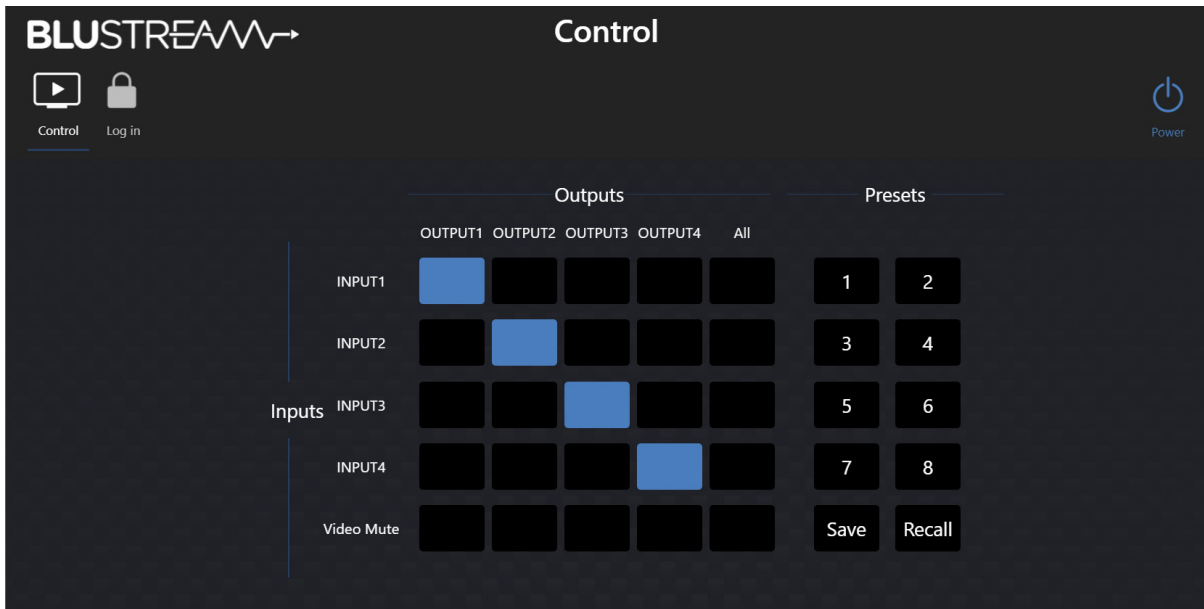

### User Control Page

The logged in User or Admin Control Page allows a user to change inputs and presets for each zone. To change inputs, simply select the square that corresponds with the input and zone output you wish to change. On the right side you can recall a preset, or save the current input/output configuration into a specified preset. There is also the ability to turn on or off the video (and audio) to each output via the Video Mute buttons.

The user can also update their password via the Update Password button, or log out via the Log Out button.

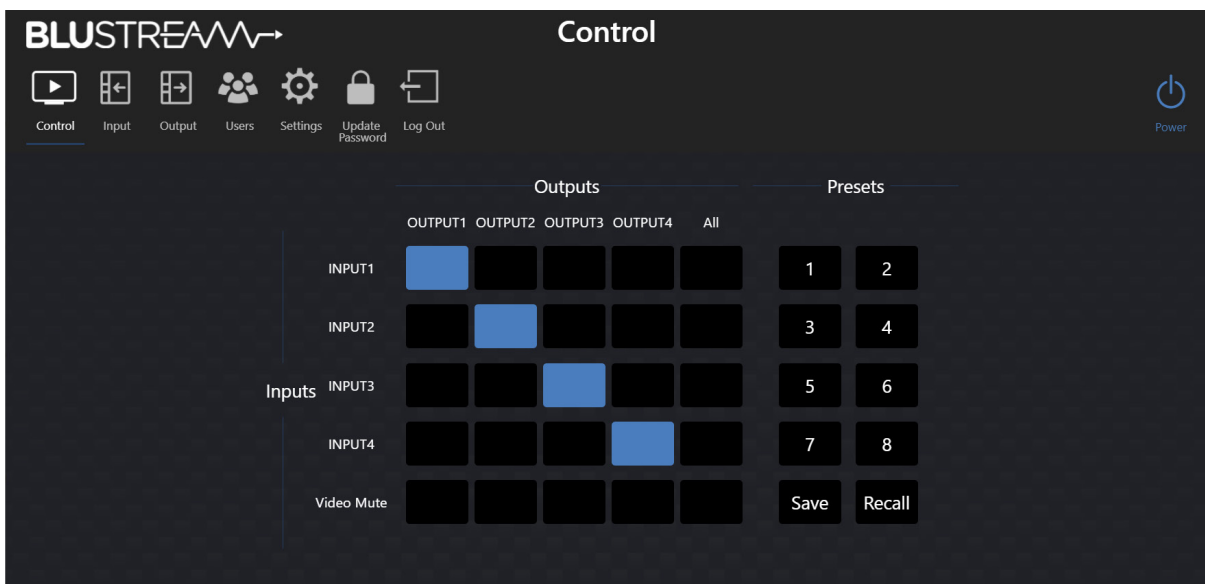



### Input Page

The Input Page allows users to change settings specific to the inputs of the matrix.

You can adjust the name of each input, the EDID of each input as select the audio source for each input, as well as see the status of HDMI cables and sources connected to each input.

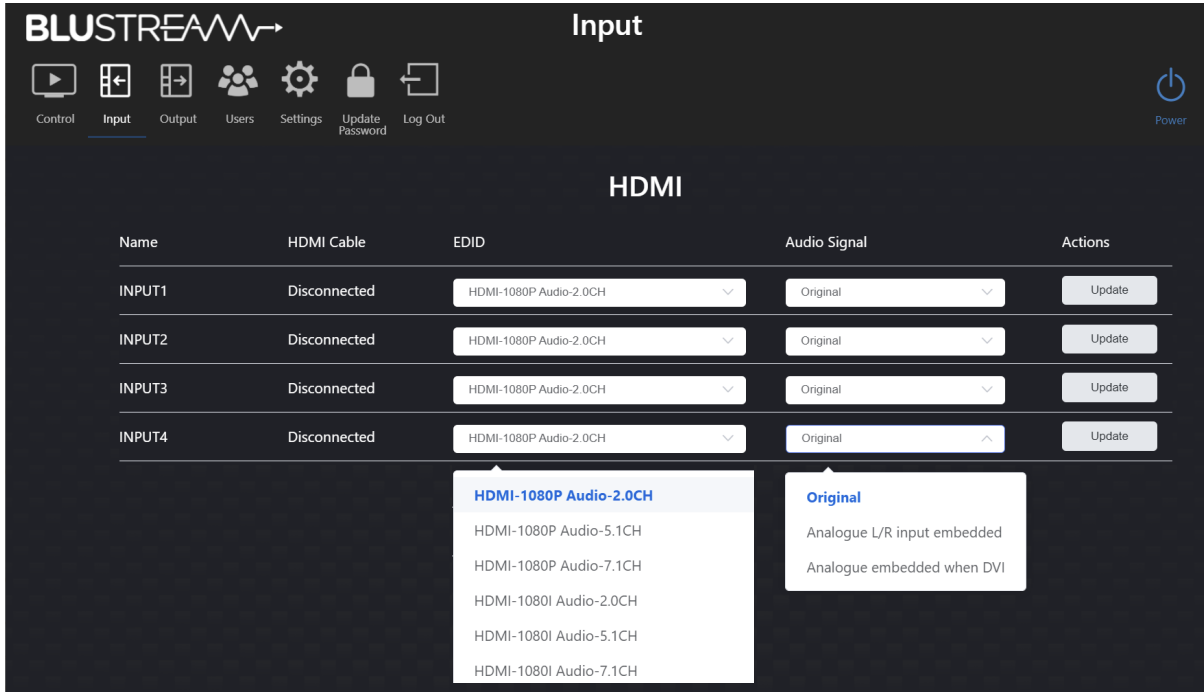

### Output Page

The Output Page allows users to change settings specific to the outputs of the matrix.

You can adjust the name of each output, adjust the output scaling between matching the TV based on its EDID, forcing a 1080p output image, or allowing the original signal to bypass without being scaled, as well as see the status of HDMI cables and displays connected to each output.

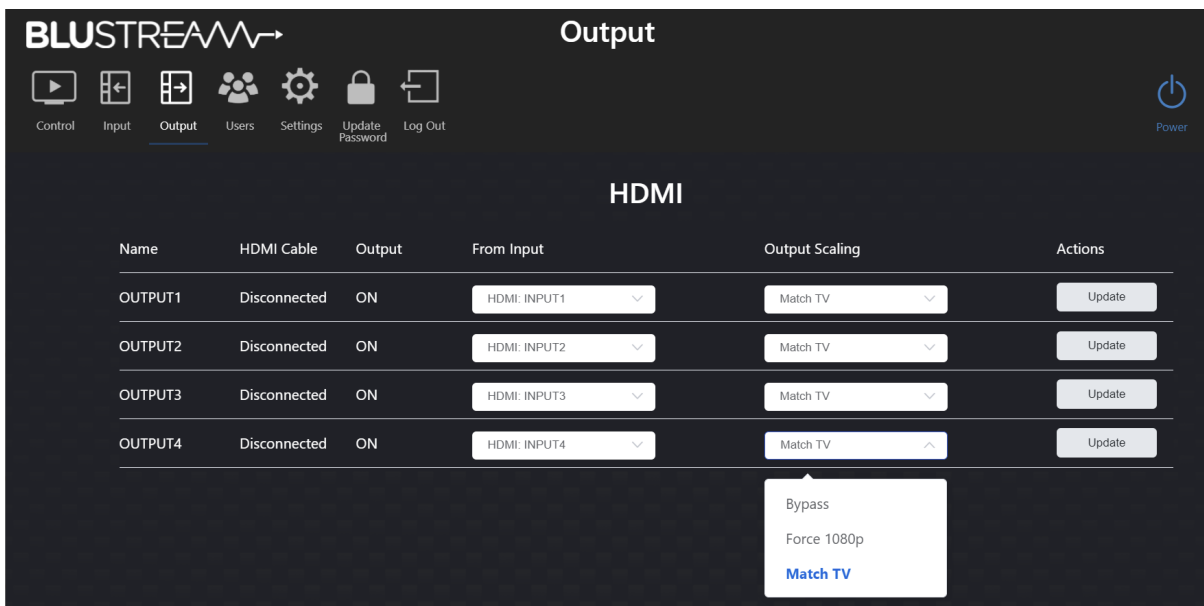

### Users Page

The Users Page allows the admin to add or remove users, or set specific permissions for inputs, outputs and presets for each user.

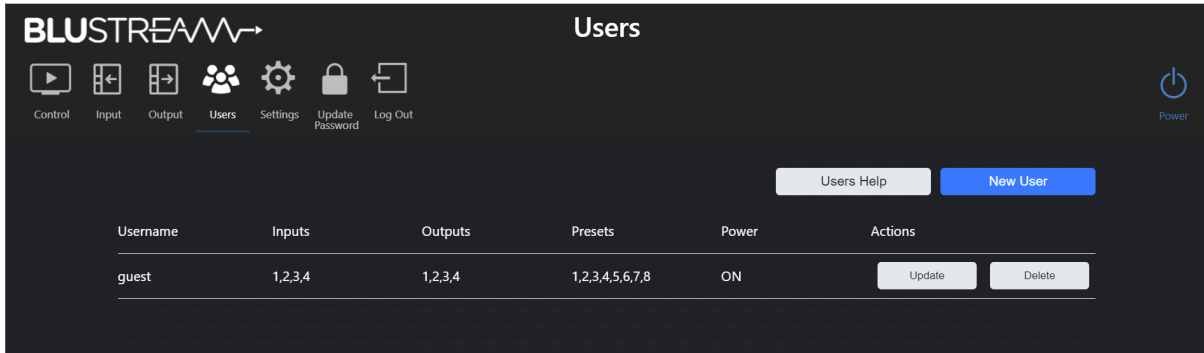

### Settings Page

The Settings Page allows you to change the settings associated with the network interface and device communication, such as:

- DHCP On/Off
- IP Address
- Gateway
- Subnet Mask
- Domain Name (mDNS name)
- RS-232 Baudrate
- Telnet Port
- IR Control On/Off
- Front Panel Buttons On/Off
- LCD Always On/Auto Timeout

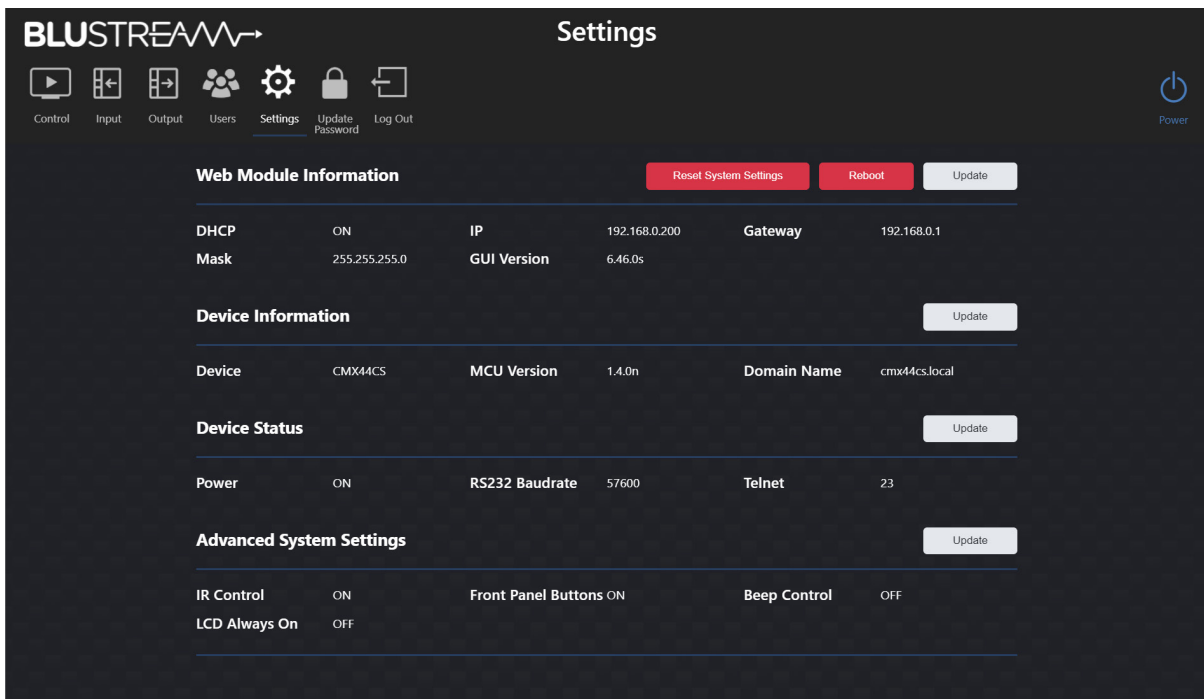





# Specifications

## CMX44CS

- **Video Input Connectors:** 4 x HDMI Type A, 19-pin, female
- **Video Output Connectors:** 4 x HDMI Type A, 19-pin, female
- **Audio Output Connectors:** 4 x RCA (S/PDIF), 4x Analogue audio L/R (3.5mm stereo Jack)
- **Audio Input Connectors:** 4 x Analogue audio L/R (3.5mm stereo Jack)
- **RS-232 Serial Port:** 1 x DB9 connector, female
- **IR Input Ports:** 5 x 3.5mm stereo jack
- **IR Output Ports:** 4 x 3.5mm mono jack
- **Rack Mountable:** 1U rack height, rack ears included
- **Casing Dimensions (W x H x D):** 440mm x 225mm x 44mm (without feet)
- **Dimensions (W x H x D):** 440mm x 231mm x 50mm
- **Shipping Weight:** 2.3kg
- **Operating Temperature:** 32°F to 104°F (0°C to +40°C)
- **Storage Temperature:** -4°F to 140°F (-20°C to +60°C)
- **Power Supply:** 12V/2A DC screw terminal

**NOTE:** Specifications are subject to change without notice. Weights and dimensions are approximate.

# Package Contents

- 1 x CMX44CS
- 1 x 12V/2A DC power supply
- 1 x Remote control
- 4 x IR emitter
- 5 x IR receiver
- 1 x Rack mounting kit
- 1 x Quick reference guide

# Maintenance

Clean this unit with a soft, dry cloth. Never use alcohol, paint thinner or benzene to clean this unit.

# RS-232 Configuration and Telnet Commands

The Blustream matrix can be controlled via serial RS-232 and TCP/IP. The RS-232 port is used for configuration and control of the product.

The default RS-232 communication settings are:

Baud rate: 57600

Data bit: 8

Stop bit: 1

Parity bit: none

The following pages list all available serial commands.

## Commonly used Serial Commands

There are several commands that are commonly used for control and testing:

<b>STATUS</b>	Status will give feedback on matrix such as zones on, type of connection etc...
<b>PON</b>	Power on
<b>POFF</b>	Power off
<b>OUTxxON</b>	(xx is the zone number you wish to turn on)
Example:-	OUT01ON (This would turn output one back on)
<b>OUTxxFRyy</b>	(xx is the zone out, yy is the input)
Example:-	OUT01FR04 (This would switch output 1 to source input 4)

## Common Mistakes

- Carriage return – Some programs do not require the carriage return where as other will not work unless sent directly after the string. In the case of some Terminal software the token <CR> is used to execute a carriage return. Depending on the program you are using this token maybe different. Some other examples that other control systems deploy include \r or 0D (in hex)
- Spaces – Blustream commands do not require space between commands unless specified. There may be some programs that require spacing in order to work.
  - How the string should look is as follows OUT01ON
  - How the string may look if spaces are required: OUT{Space}01{Space}ON
- Baud rate or other serial protocol settings not correct

# RS-232 Configuration and Telnet Commands

COMMAND	ACTION
? / HELP	Print Help Information
STATUS	Print System Status And Port Status
FWVER	Print All Firmware Version
PON/POFF	Power On Or Off Device
REBOOT	Set System And Network Reboot
IR ON/OFF	Set System IR Control On Or Off
KEY ON/OFF	Set System KEY Control On Or Off
BEEP ON/OFF	Set Onboard Beep On Or Off
LCD ON/OFF	Set Front Panel LCD Always On Or Auto Turn Off In Power On State
RSB x	Set RS232 Baud Rate to X bps x=[0:115200 1:57600, 2:38400, 3:19200, 4:9600]
RESET	Reset System To Default Setting
RESET ALL	Reset System And Network To Default Setting (Should Type ""Yes"" To Confirm, ""No"" To Discard)"
OUT xx ON/OFF	Set Output:xx On Or Off
OUT xx SCALING yy	Set Output:xx Video Mode yy xx=00: Select All Output Port xx=[01...04]: Select One Output Port yy=[01]: Select Output Port Video Mode Bypass yy=[02]: Select Output Port Video Mode Force_1080p yy=[03]: Select Output Port Video Mode Match TV
OUT xx FR yy	Set Output:xx From Input:yy
EDID xx CP yy	Set Input:xx EDID Copy From Output:yy
EDID xx DF zz	Set Input:xx EDID To Default EDID:zz xx=00: Select All Input Port xx=[01...04]: Select One Input Port yy=[01...04]: Select One Output Port zz=00: HDMI 1080p@60Hz, Audio 2CH PCM zz=01: HDMI 1080p@60Hz, Audio 5.1CH DTS/DOLBY zz=02: HDMI 1080p@60Hz, Audio 7.1CH DTS/DOLBY/HD zz=03: HDMI 1080i@60Hz, Audio 2CH PCM zz=04: HDMI 1080i@60Hz, Audio 5.1CH DTS/DOLBY zz=05: HDMI 1080i@60Hz, Audio 7.1CH DTS/DOLBY/HD zz=06: HDMI 1080p@60Hz/3D, Audio 2CH PCM zz=07: HDMI 1080p@60Hz/3D, Audio 5.1CH DTS/DOLBY zz=08: HDMI 1080p@60Hz/3D, Audio 7.1CH DTS/DOLBY/HD zz=09: HDMI 4K@30Hz 4:4:4, Audio 2CH PCM zz=10: HDMI 4K@30Hz 4:4:4, Audio 5.1CH DTS/DOLBY zz=11: HDMI 4K@30Hz 4:4:4, Audio 7.1CH DTS/DOLBY/HD zz=12: DVI 1280x1024@60Hz, Audio None zz=13: DVI 1920x1080@60Hz, Audio None zz=14: DVI 1920x1200@60Hz, Audio None zz=15: User EDID 1 zz=16: User EDID 2 zz=17: GUI Download EDID zz=18: HDMI 4K@60Hz 4:2:0, Audio 2CH PCM zz=19: HDMI 4K@60Hz 4:2:0, Audio 5.1CH DTS/DOLBY zz=20: HDMI 4K@60Hz 4:2:0, Audio 7.1CH DTS/DOLBY/HD zz=21: HDMI 4K@60Hz 4:4:4, Audio 2CH PCM zz=22: HDMI 4K@60Hz 4:4:4, Audio 5.1CH DTS/DOLBY zz=23: HDMI 4K@60Hz 4:4:4, Audio 7.1CH DTS/DOLBY/HD
PRESET STATUS	Print Preset Config Status
PRESET pp SET aa,bb,cc,dd	Set Preset:pp Config
PRESET pp SAVE	Save Current Output Connection To Preset:pp Config
PRESET pp APPLY	Apply Preset:pp Config To Output Connection pp=[01..08]: Select Preset Index aa=[01..04]: Output 01 From aa, [00]: Not Set bb: Output 02 ... dd: Output 04
AUD RX xx ORG	Input Port:xx Use Original Receive HDMI/DVI Signal
AUD RX xx ANA	Input Port:xx Embedded Analogue L/R To HDMI/DVI Signal
AUD RX xx AUTO	Input Port:xx Embedded Analogue L/R When DVI Signal xx=[00]: All Input Port, [01...04]: Input Port
NET DHCP ON/OFF	Set Auto IP (DHCP) ON Or OFF
NET IP xxx.xxx.xxx.xxx	Set IP Address
NET GW xxx.xxx.xxx.xxx	Set Gateway Address
NET SM xxx.xxx.xxx.xxx	Set Subnet Mask Address
NET RB	Network Reboot and Apply New Config!!!
NET TN xxxx	Set Telnet Port
NET DNS xxxx	Set DNS Domain Name To xxxx

Schematic

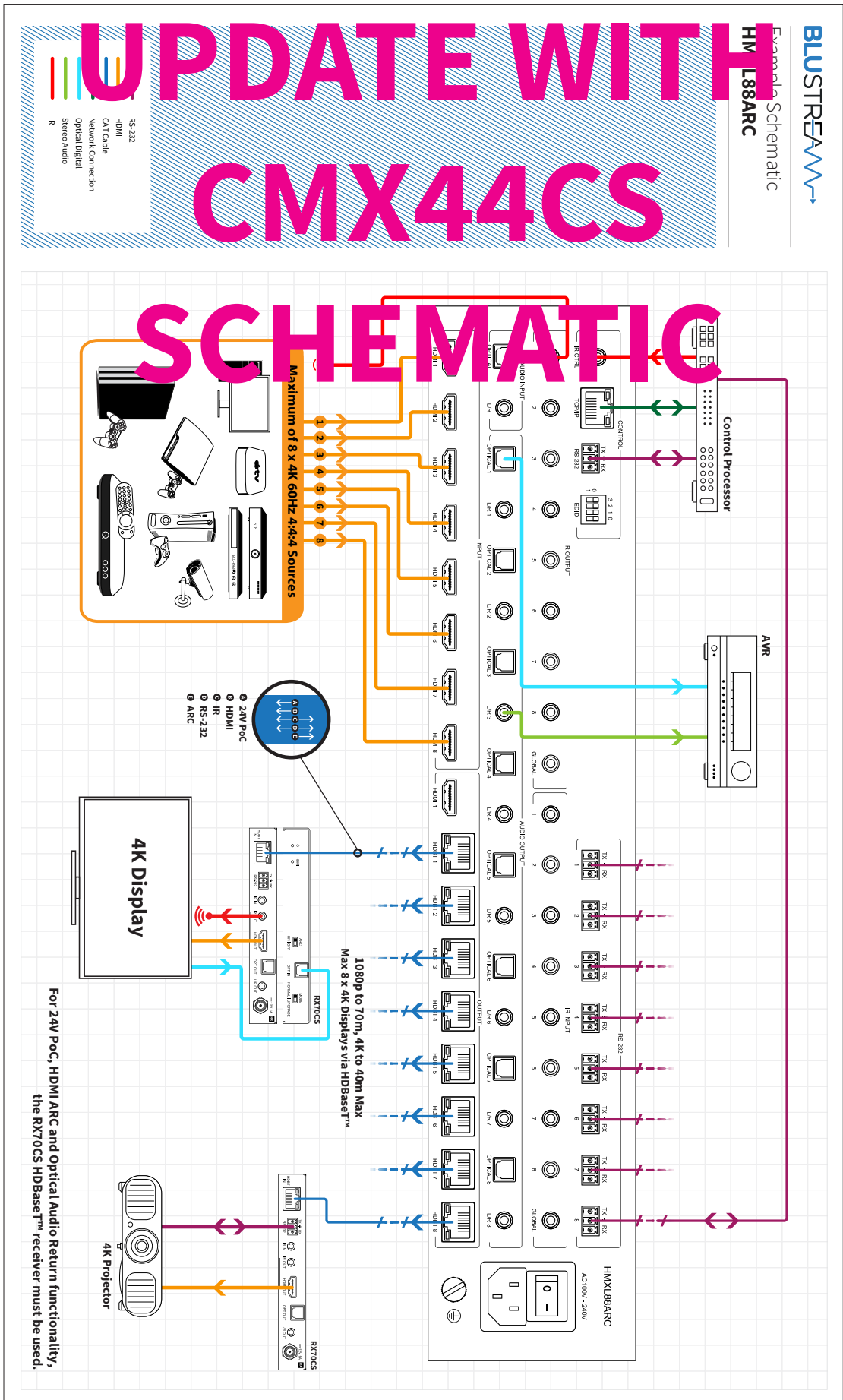



# Certifications

## FCC Notice

This equipment has been tested and found to comply with the limits for a Class B digital device, pursuant to part 15 of the FCC Rules. These limits are designed to provide reasonable protection against harmful interference in a residential installation. This equipment generates, uses, and can radiate radio frequency energy and, if not installed and used in accordance with the instructions, may cause harmful interference to radio communications. However, there is no guarantee that interference will not occur in a particular installation. If this equipment does cause harmful interference to radio or television reception, which can be determined by turning the equipment off and on, the user is encouraged to try to correct the interference by one or more of the following measures:

- Reorient or relocate the receiving antenna.
- Increase the separation between the equipment and receiver.
- Connect the equipment into an outlet on a circuit different from that to which the receiver is connected.
- Consult the dealer or an experienced radio/TV technician for help.

**CAUTION** - changes or modifications not expressly approved by the party responsible for compliance could void the user's authority to operate the equipment.

## CANADA, INDUSTRY CANADA (IC) NOTICES

This Class B digital apparatus complies with Canadian ICES-003.

Operation is subject to the following two conditions: (1) this device may not cause interference, and (2) this device must accept any interference, including interference that may cause undesired operation of the device.

## CANADA, AVIS D'INDUSTRY CANADA (IC)

Cet appareil numérique de classe B est conforme aux normes canadiennes ICES-003.

Son fonctionnement est soumis aux deux conditions suivantes : (1) cet appareil ne doit pas causer d'interférence et (2) cet appareil doit accepter toute interférence, notamment les interférences qui peuvent affecter son fonctionnement.

## CORRECT DISPOSAL OF THIS PRODUCT

This marking indicates that this product should not be disposed with other household wastes. To prevent possible harm to the environment or human health from uncontrolled waste disposal, recycle it responsibly to promote the sustainable reuse of material resources. To return your used device, please use the return and collection systems or contact the retailer where the product was purchased. They can take this product for environmentally safe recycling.





[www.blustream.com.au](http://www.blustream.com.au)  
[www.blustream-us.com](http://www.blustream-us.com)  
[www.blustream.co.uk](http://www.blustream.co.uk)