



Controllers

User Manual

Contents

2	Contents	44	Upload User Application
3	Introduction	44	Overview
3	Overview	44	Using Cue Visual Composer
3	Common Features	45	Using Admin Web
4	Models and Specifications	46	Admin Web
4	Tabletop Models	46	Access Admin Web
4	DIN Rail Models	46	Login
5	Lightweight Controllers	46	Configuration
6	Accessories	48	Date and Time
7	Box Contents	49	Applications
7	Controllers	49	File Storage
7	Lightweight Controllers	49	E-mail
8	Mechanical Description	50	System
8	Tabletop Models	50	Password
10	DIN Rail Models	51	Backup
12	Lightweight Controllers	52	Reset
13	Mounting	52	Logout
13	Shelf Placement or Stacking	52	License
13	Rack Mounting	53	Software and Firmware License
14	Factory and System Default	54	Notes
15	Indicators		
15	General		
15	Control Ports		
16	IR Sensor		
16	Overview		
16	IR Codes Capturing		
17	IR Control Panels Receiver		
18	Connecting		
18	Overview		
19	PWR IN		
20	Power over Ethernet		
21	CUEnet (LAN)		
23	SERIAL		
26	VERSATILE		
35	IR/SERIAL		
36	GENERAL I/O		
37	RELAY		
38	AUDIO LINE		
39	DALI		
40	KNX		
41	DMX		
42	EnOcean		
43	CUEwire Device Connection		

Introduction

Overview

Ethernet IP enabled controllers equipped with variety types of control ports. Control ports include bi-directional serial channels RS-232/422/485, serial outputs, versatile ports, infrared outputs, general I/Os, 24 volts relay outputs, DALI, KNX, DMX512 and EnEcean ports.

The Ethernet port allows for bi-directional IP control of any manufacturer IP enabled products. All models are fully compatible with CUE's existing range of button panels and touch panels through and comes equipped with a CUewire port.

For lightweight controllers, IP communication is CUenet2 only, that means IP device control and e-mails are not supported.

Internal IR sensor allows capture IR codes and, for some models, receive IR codes from hand-held transmitters. Convenient for testing and troubleshooting this model also comes with front panel indicator LEDs that indicate the status of all the control ports.

The controller keeps date and time with its on-board real time clock (RTC) and thus allowing for a wide variety of distributed intelligence scheduling applications.

For most of controllers, single cable Ethernet connection provides easy network integration. The controllers are equipped with Power over Ethernet (PoE) technology enabling an Ethernet network cable to deliver both data and power.

This controller comes complete with a web server and allows setup through a standard web browser. Unit programming is based on CUE's standard programming tool Cue Visual Composer.

All models comes complete with a web server and allow for setup through a standard web browser.

Aluminium enclosure allows tabletop or 19" rack using Rack Mounting kit. In addition many DIN rail compatible models are available.

Common Features

- Ethernet IP enabled controllers
- Modern ARM® processor platform
- On-board real time clock
- Wired 10/100 BaseT LAN
- Bi-directional control of any IP enabled products through Ethernet port (except lightweight controllers)
- Variety types of control ports
- Bi-directional serial RS-232/485
- Bidirectional serial RS-422 (controlCUE-one and controlCUE-two only)
- IR /serial outputs (IR up to 1.2 MHz)
- General I/Os (controlCUE-one and controlCUE-two) or Versatile port (other controllers)
- Relays NO-C-NC 24 V
- Real time clock (RTC) for scheduling applications
- Web server and Admin Web for setup through a standard web browser
- Aluminium enclosure design for desktop and 19" rack or DIN rail plastic enclosure
- Various accessories available

Models and Specifications

Tabletop Models



controlCUE-versatile



controlCUE-one



controlCUE-two

Product code	CS0475	CS0412	CS0414
RAM / Non-volatile flash	64 MB / 256 MB	512 MB / min. 4 GB	512 MB / min. 4 GB
IR receiver for capture	1	1	1
IR receiver for wireless control panels	-	1	1
Wired 10/100 BaseT Ethernet	1	1	1
Bi-directional serial RS-232/485	3		
Bi-directional serial RS-232/422/485	-	2	6
Versatile port	8		
IR/Serial output	-	4	8
General I/O (analog in / digital out)	-	4	8
Low-voltage relay 24 V / 0.5 A	-	2	4
Audio	-	Line in, line out	Line in, line out
Power supply	24 VDC / max. 4 W PoE, IEEE 802.3af / Class 0	24 VDC / max. 4 W	24 VDC / max. 4 W
Enclosure	Aluminium	Aluminium	Aluminium
Dimensions	105 x 43.5 x 92 mm	210 x 43.5 x 92 mm	210 x 43.5 x 92 mm
Weight	0.3 kg	0.5 kg	0.6 kg
Included accessories	Wall power supply 24 VDC / 24 W, 2x IR Adapter /i, Connector set, Ethernet cable	Wall power supply 24 VDC / 24 W, 4x IR Adapter /i, Connector set, Ethernet cable	Wall power supply 24 VDC / 24 W, 4x IR Adapter /i, Connector set, Ethernet cable
Recommended accessories (has to be ordered separately)	Rack Mounting Shelf, IR Adapter /i, Opto-Input Adapter /i, Serial cables, Current Loop Adapter	Rack Mounting Shelf, IR Adapter /i, Opto-Input Adapter /i, Serial cables	Rack Mounting Shelf, IR Adapter /i, Opto-Input Adapter /i, Serial cables

DIN Rail Models



controlCUE-versatile-d



controlCUE-dali-d



controlCUE-knx-d



controlCUE-dmx-d



controlCUE-enocean-d

Product code	CS0453	CS0454	CS0455	CS0456	CS0458
RAM / Non-volatile flash	64 MB / 256 MB	64 MB / 256 MB	64 MB / 256 MB	64 MB / 256 MB	64 MB / 256 MB
IR receiver for capture	1	1	1	1	1
Wired 10/100 BaseT Ethernet	1	1	1	1	1
Bi-directional serial RS-232/485	3	1	1	1	1
Versatile port	8	4	4	4	4
DALI	-	1	-	-	-
KNX	-	-	1	-	-
DMX512	-	-	-	2	-
EnOcean RF	-	-	-	-	1
Power supply	24 VDC / max. 4 W PoE, IEEE 802.3af / Class 0				
Enclosure	Plastic, DIN rail, 4 M				
Dimensions	70 x 90 x 58 mm				
Weight	0.2 kg				
Included accessories	DIN rail power supply 24 VDC / 15 W, 2x IR Adapter /i, Connector set, Ethernet cable				
Recommended accessories (has to be ordered separately)	IR Adapter /i, Opto-Input Adapter /i, Serial cables, Current Loop Adapter				

Lightweight Controllers



smartCUE-relay







smartCUE-versatile







smartCUE-versatile-d

Product code	CS0496	CS0491	CS0492
IR receiver for capture	1	1	1
Wired 10/100 BaseT Ethernet	1	1	1
Bi-directional serial RS-232/485	3	3	3
Versatile port	6	8	6
Low-voltage relay 24 V / 0.5 A	6	-	-
Power supply	24 VDC / max. 4 W PoE, IEEE 802.3af / Class 0	24 VDC / max. 4 W PoE, IEEE 802.3af / Class 0	24 VDC / max. 4 W PoE, IEEE 802.3af / Class 0
Enclosure	Aluminum Protection IP20	Aluminum Protection IP20	Plastic, DIN rail, 4 M Protection IP20
Dimensions	105 x 43.5 x 92 mm	105 x 43.5 x 92 mm	70 x 90 x 58 mm
Weight	0.3 kg	0.3 kg	0.2 kg
Included accessories	Wall power supply 24 VDC / 24 W, 2x IR Adapter /i, Connector set, Ethernet cable	Wall power supply 24 VDC / 24 W, 2x IR Adapter /i, Connector set, Ethernet cable	DIN rail power supply 24 VDC / 15 W, 2x IR Adapter /i, Connector set, Ethernet cable
Recommended accessories (has to be ordered separately)	Rack Mounting Shelf, IR Adapter /i, Opto-Input Adapter /i, Serial cables, Current Loop Adapter	Rack Mounting Shelf, IR Adapter /i, Opto-Input Adapter /i, Serial cables, Current Loop Adapter	IR Adapter /i, Opto-Input Adapter /i, Serial cables, Current Loop Adapter

Accessories

				
	IR Adapter /i	Opto-Input Adapter /i	Serial IO Cable DTE /i	Serial IO Cable DCE /i
Product code	CS0256	CS0257	CA0181-P05 (length 0.5 m) CA0181-P30 (length 3.0 m) CA0181-PU (user length)	CA0182-P05 (length 0.5 m) CA0182-P30 (length 3.0 m) CA0182-PU (user length)
Description	Infra-red emitter compatible with IR/Serial output and versatile port Mounting on the receiver window with double-sided adhesive tape Cable length 2 m	Photosensitive cell sensor compatible with General I/O and Versatile port Mounting on the indicator with double-sided adhesive tape Cable length 2 m	RS-232 serial cable DTE	RS-232 serial cable DCE
Connectors	2-pin, 3.5 mm	2-pin, 3.5 mm	5-pin, 3.5 mm DB-9-M (controlled device)	5-pin, 3.5 mm DB-9-F (controlled device)

				
	Serial Cable 5-pin to RJ-14	Serial Cable 3-pin to RJ-14	Current Loop Adapter	UTP Organiser
Product code	CA0183	CA0184	CS0479	CS0422
Description	RS-485 serial cable between controller and power switching units, dimmers and interfaces	RS-485 serial cable between controller and power switching units, dimmers and interfaces	Adapter allowing to connect current loop (0/4 - 20 mA) outputs to versatile port	Brings all 8 pins of RJ-45 connector to 8-pin Phoenix type connector DIN rail compatible
Connectors	5-pin, 3.5 mm RJ-14	3-pin, 3.5 mm RJ-14	2-pin, 3.5 mm, male 2-pin, 3.5 mm, female	8-pin, 3.5 mm RJ-45

	
	Rack Mounting Shelf
Product code	CS0449
Description	19" rack mounting kit for tabletop controllers
Enclosure	Stainless steel
Dimensions	Rack 19", 1 U
Weight	1.3 kg

Box Contents

Controllers



controlCUE-versatile



controlCUE-one



controlCUE-two

Product code	CS0475	CS0412	CS0414
Controller controlCUE-versatile	1		
Controller controlCUE-one		1	
Controller controlCUE-two			1
Power supply 24 VDC	1	1	1
Ethernet cable straightthrough	1	1	1
IR Adapter /i	2	4	4
Connector set	1	1	1
Declaration of Conformity	1	1	1
Data Sheet	1	1	1
Cue System Connector Wiring	1	1	1



controlCUE-versatile-d



controlCUE-dali-d



controlCUE-knx-d



controlCUE-dmx-d



controlCUE-enocean-d

Product code	CS0453	CS0454	CS0455	CS0456	CS0458
Controller controlCUE-versatile-d	1				
Controller controlCUE-dali-d		1			
Controller controlCUE-knx-d			1		
Controller controlCUE-dmx-d				1	
Controller controlCUE-enocean-d					1
DIN rail power supply 24 VDC	1	1	1	1	1
Ethernet cable straightthrough	1	1	1	1	1
IR Adapter /i	2	2	2	2	2
Connector set	1	1	1	1	1
Declaration of Conformity	1	1	1	1	1
Data Sheet	1	1	1	1	1
Cue System Connector Wiring	1	1	1	1	1

Lightweight Controllers



smartCUE-relay



smartCUE-versatile



smartCUE-versatile-d

Product code	CS0496	CS0491	CS0492
Controller smartCUE-relay	1		
Controller smartCUE-versatile		1	
Controller smartCUE-versatile-d			1
Power supply 24 VDC	1	1	1
Ethernet cable straightthrough	1	1	1
IR Adapter /i	2	4	4
Connector set	1	1	1
Declaration of Conformity	1	1	1
Data Sheet	1	1	1
Cue System Connector Wiring	1	1	1

Mechanical Description

Tabletop Models

controlCUE-versatile

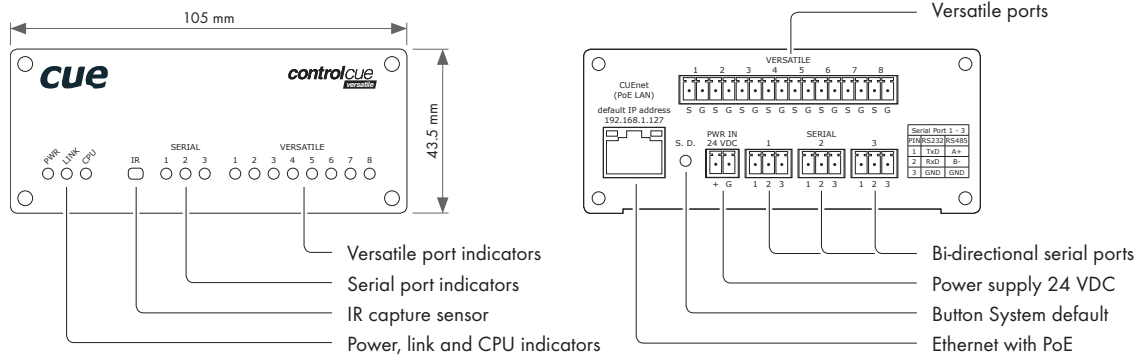

controlCUE-one

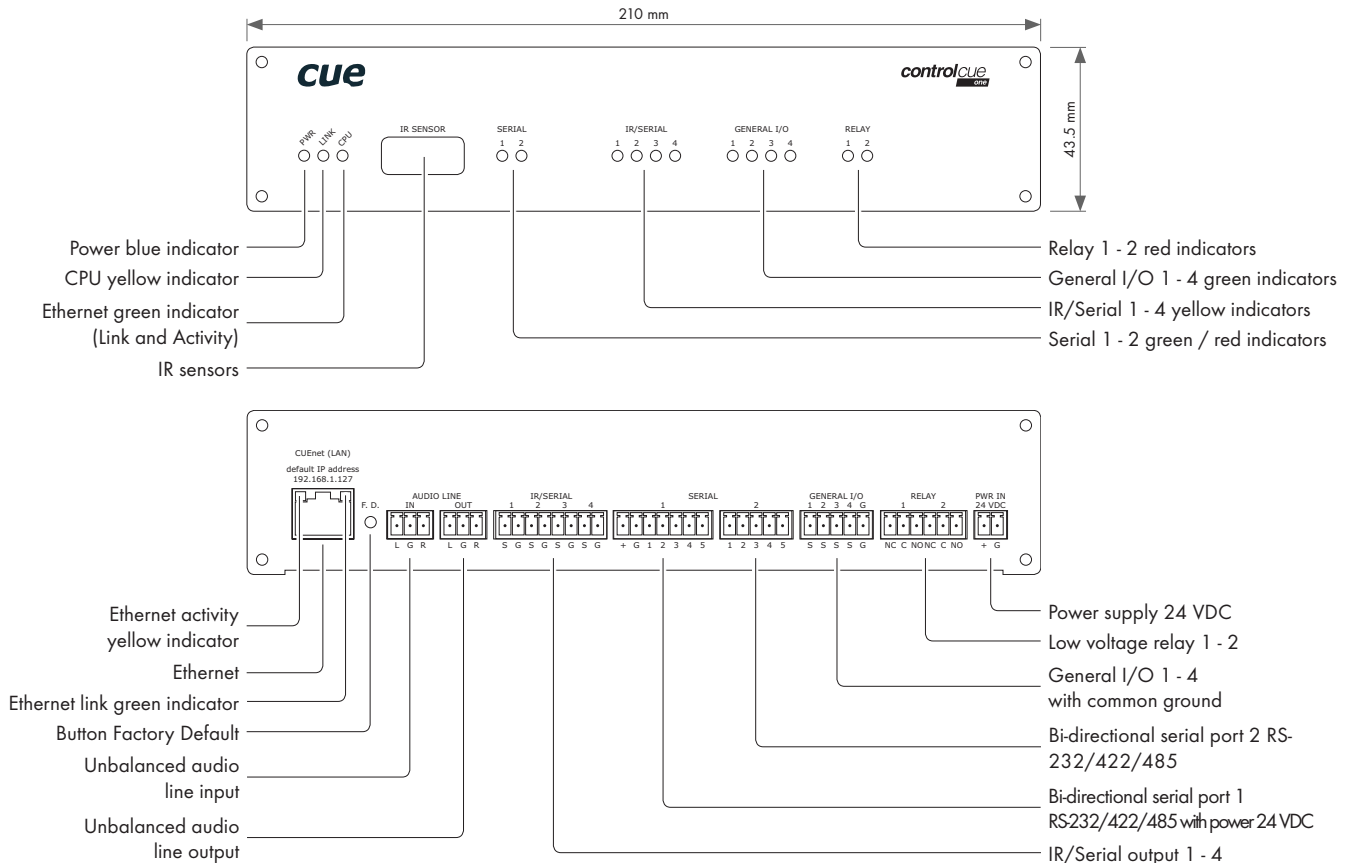

controlCUE-two

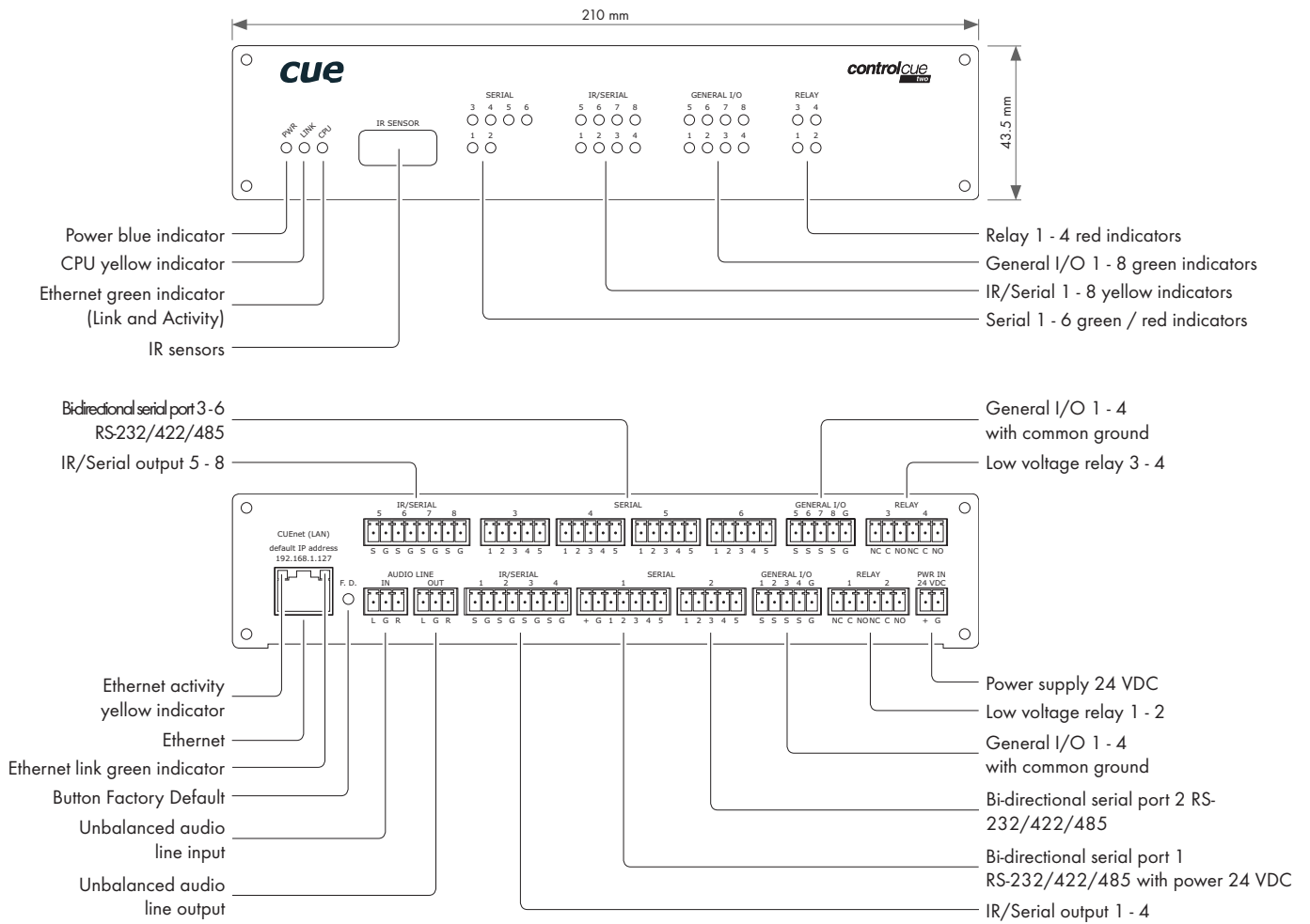

DIN Rail Models

All DIN rail models are equipped with black plastic DIN rail compatible 4 modules enclosure.

controlCUE-versatile-d

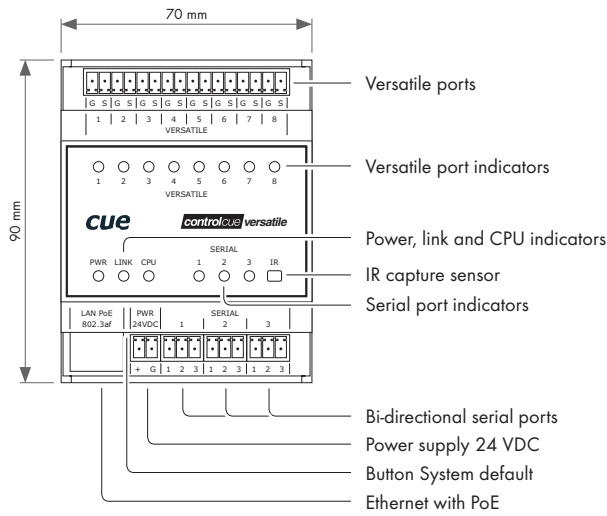

controlCUE-dali-d

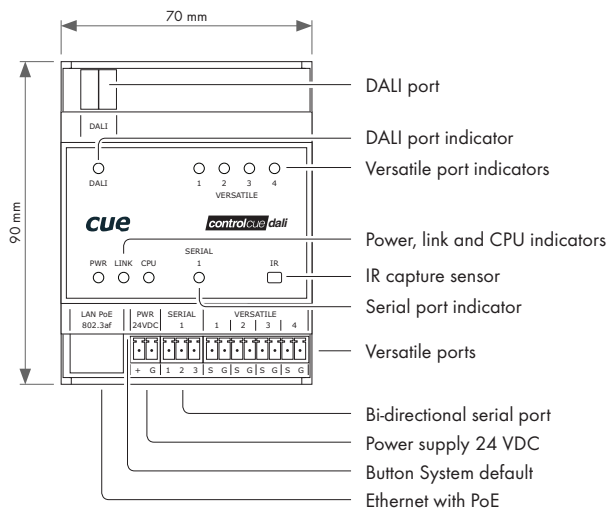

controlCUE-knx-d

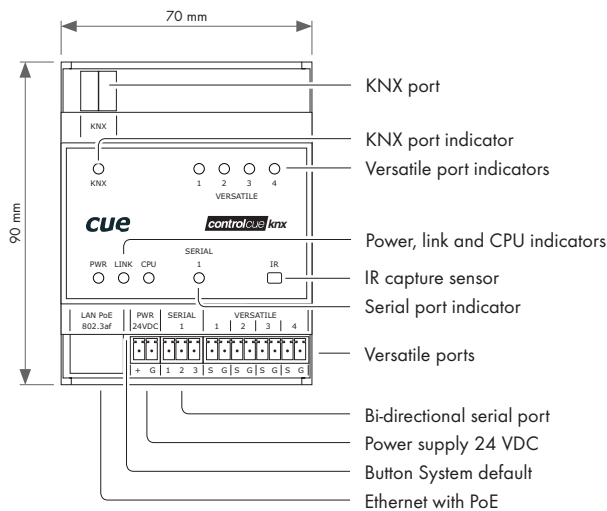

controlCUE-dmx-d

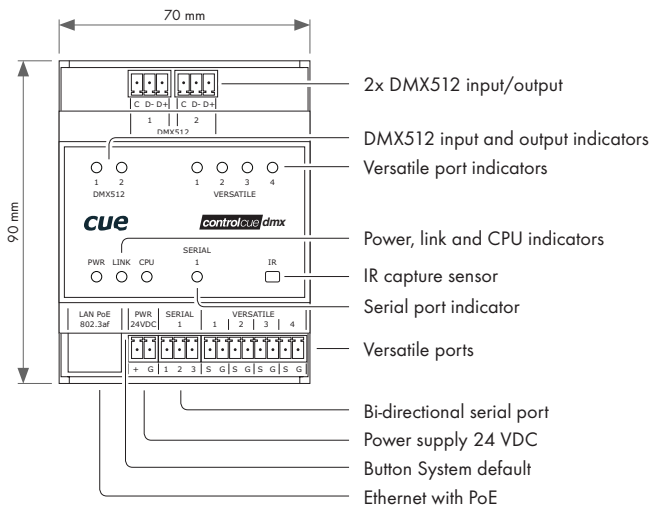

controlCUE-enocean-d

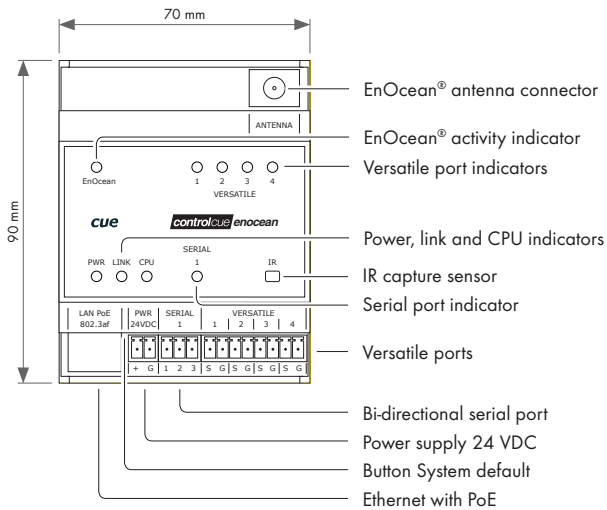

Lightweight Controllers

smartCUE-relay

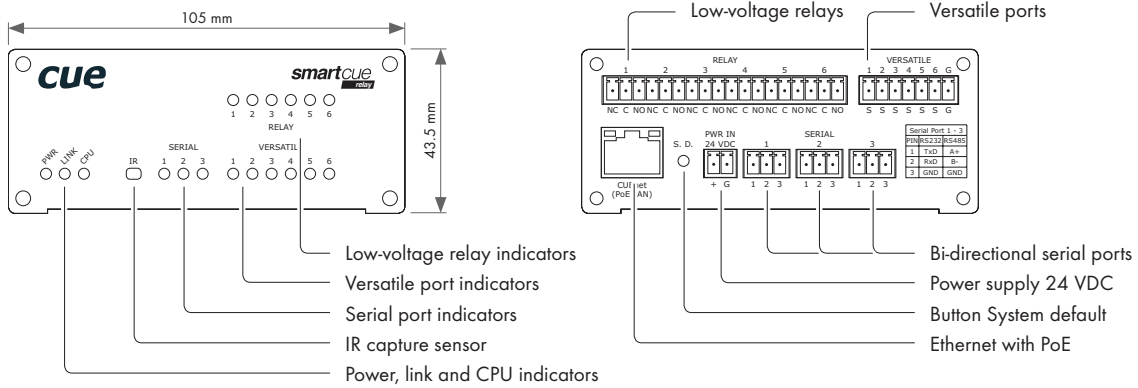

smartCUE-versatile

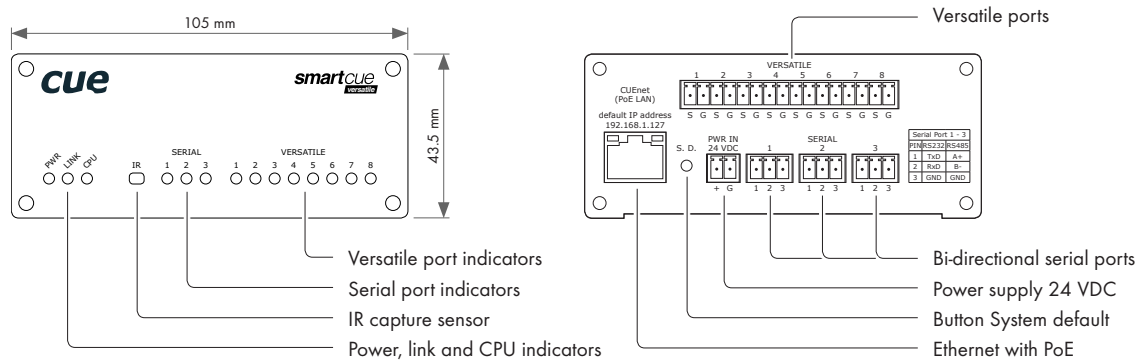

smartCUE-versatile-d

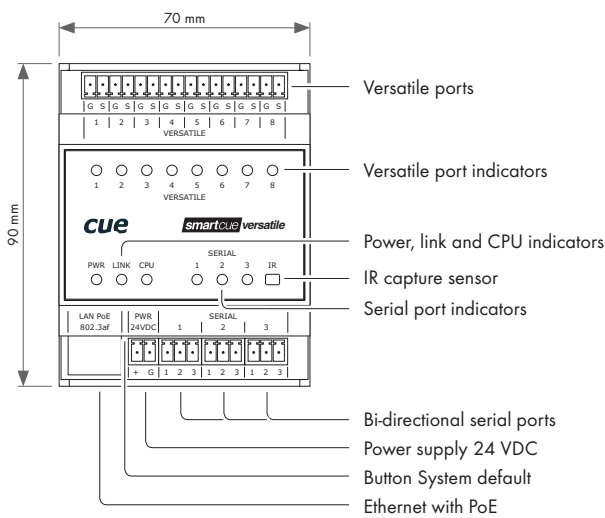

Mounting

Shelf Placement or Stacking

Four rubber feet are provided for shelf placement or stacking. Stick the rubber feet near the corner edges on the bottom side of controllers - see picture below.

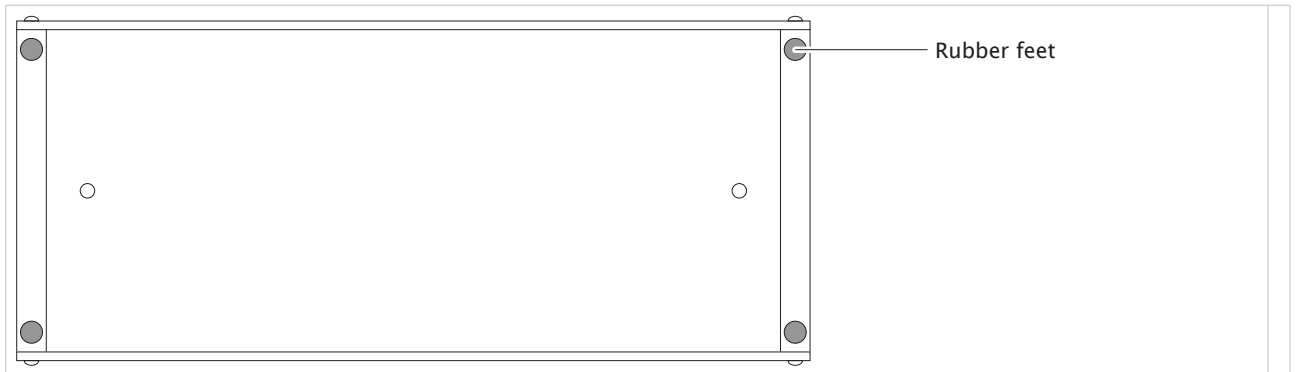

Rack Mounting

The Rack Mounting Shelf (CS0449) provides simple solution for installing controllers to the 19" rack. It allows to install up to two half-rack sized controllers to single 19" unit rack space. All necessary accessories are supplied with the shelf.

Controller is fixed to the Rack Mounting Shelf by two screws M3 x 6 using female threads on the bottom side of controller - see picture below. Screws M3 x 6 are bundled with Rack Mounting Shelf. Don't use longer screws to avoid damage of PCBs inside the unit. If you install only one controller use cover panel delivered with the shelf.

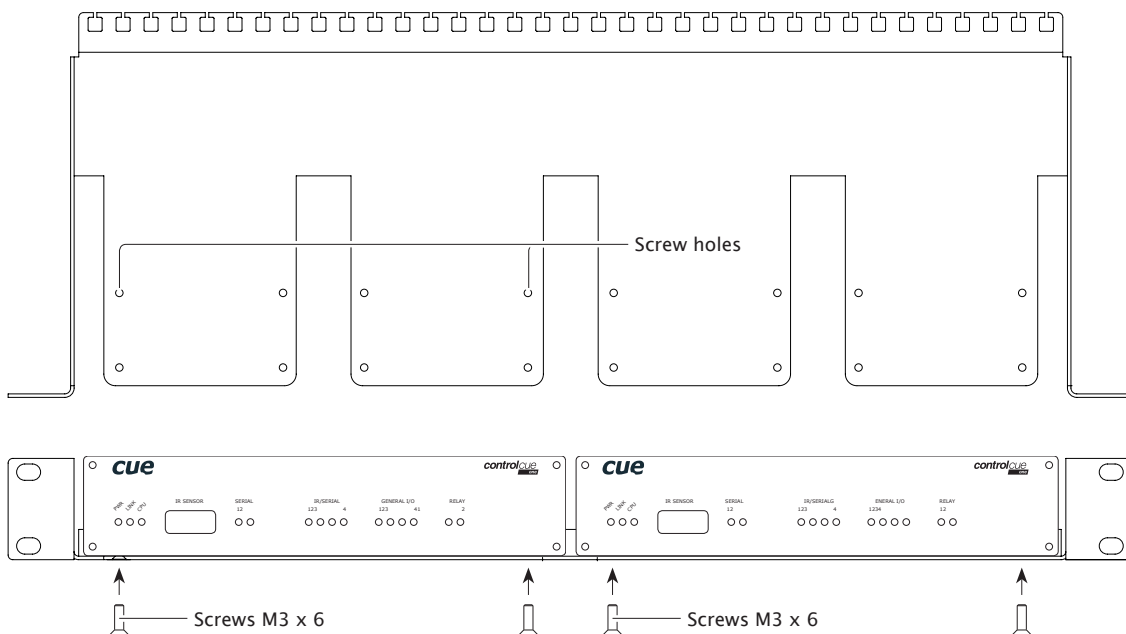

If you install less controllers, use cover panels delivered with the shelf to cover empty positions.

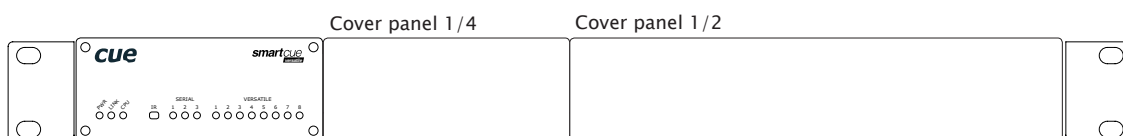

Factory and System Default

Every device shipped from the factory is set according to table bellow, Factory Default column.



Restoring System Default function is provided by pressing of the button **System Default** (S.D.). The main purpose of this functionality is to regain connection with lost password or unknown IP settings. Press button S.D. until the CPU LED indicator will flash to confirm the system default function is performed according to table above, System Default column. A thin screwdriver is needed for press of S.D. button.

Factory and System Default settings is described in the following table.











			Factory Default	System Default
Configuration	Identification	Magic name	controlCUE-x-x_CS0000.R00.000000	Not changed
	IP settings	DHCP	On	On
		IP address (alternate)	192.168.1.127	192.168.1.127
		Subnet mask	255.255.255.0	255.255.255.0
		Default gateway	192.168.1.1	192.168.1.1
	DNS	Primary DNS server	Empty	Not changed
		Secondary DNS server	Empty	Not changed
Date and time	Date and Time	Day, month, year	Real	Not changed
		Hour, minute, second	Real	Not changed
		Time zone	(UTC) Coordinated Universal Time	Not changed
	Internet clock	Use Internet clock	Not	Not changed
		Primary NTP server	Empty	Not changed
		Secondary NTP server	Empty	Not changed
Applications			Empty	Not changed
File storage			Empty	Not changed
System	Firmware		Current version	Not changed
Password			Empty	Empty

Indicators

General

Indicator	Color	Off	On / Flashing
 POWER	Blue	No power presented.	Power is presented. The unit is ready.
 LINK	Green	Network is not detected.	Network link / activity
 CPU	Yellow	No activity.	System default indication.

Control Ports

Indicator	Color	Off	On / Flashing
 ANALOG	Yellow	Analog output is set to 0 V.	Analog output is set to 10 V.
 DALI	Green Red	No data activity.	Data activity.
 DIGITAL I/O	Green	Output is switched OFF.	Output is switched ON.
 DMX512	Green Red	No data activity.	Data activity.
 EnOcean	Green Red	No data activity.	Data activity.
 GENERAL I/O	Green	Output is switched OFF.	Output is switched ON.
 IR/SERIAL	Yellow	No data or IR code transmitted.	Data or IR code is being transmitted.
 KNX	Green Red	No data activity.	Data activity.
 RELAY	Red	Relay is switched OFF.	Relay is switched ON.
 SERIAL	Green Red	No data transmitted or received.	Data is being transmitted. Data is being received.
 VERSATILE	Green Yellow	Output is switched OFF. No data or IR code transmitted.	Output is switched ON. Data or IR code is being transmitted.

IR Sensor

Overview

The following table describes functionality of IR sensor for various types of controllers.

Controller	IR codes capture	IR control panels receiver
controlCUE-versatile	✓	
controlCUE-one	✓	✓
controlCUE-two	✓	✓
controlCUE-versatile-d	✓	
controlCUE-dali-d	✓	
controlCUE-knx-d	✓	
controlCUE-dmx-d	✓	
controlCUE-enocean-d	✓	
smartCUE-versatile	✓	
smartCUE-versatile-d	✓	
smartCUE-relay	✓	

IR Codes Capturing

Overview

All controllers are equipped with an IR capture sensor and are able to capture IR codes. Captured IR codes can be used in all types of controllers, touch panels and touch panel controllers.

Capture

The capture procedure consists of the following steps:

- Connect the capture unit and the PC with Cue Visual Composer to the same Network.
- Arrange the IR remoter and the capture unit as described below.

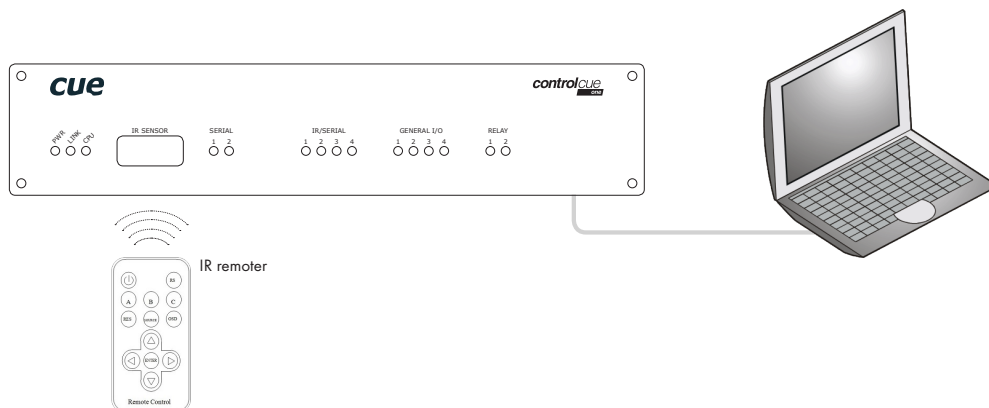

- Pay attention to set the proper distance between the capturing unit and the remoter according to the needs of the capturing unit.

- Start Cue Visual Composer and go to the appropriate driver and command.
- Set the IP address of the unit used for capture.
- Push the Start Capture button in Cue Visual Composer and then press the appropriate button on the IR remoter.

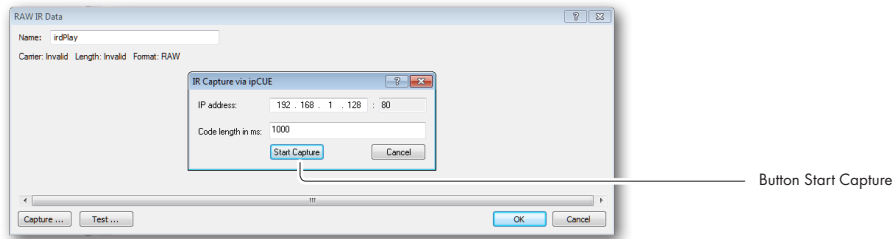

IR Control Panels Receiver

The built-in IR sensor carries the same functionality as other IR receivers. This means that controlCUE can receive IR signal from CUE wireless IR control panels without the need to use any external IR receiver.

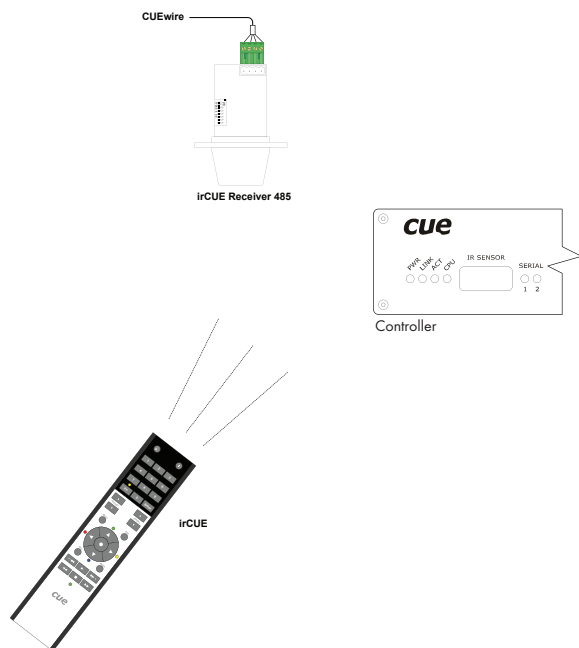

The irCUE is connected to the rest of the control system via IR communication.

As the IR receiver you can use

- The irCUE Receiver 485 external unit
- IR receiver built into ipCUE and controlCUE controllers
- IR receiver built into keypadCUE-8-L and keypadCUE-8-E keypads.

Connecting

Overview

The following table describes connections for all controllers.

Unit	Connection												
	Power supply 24 VDC	Power over Ethernet	Ethernet	Serial RS-232/485	Serial RS-232/422/485	IR/Serial output	Versatile	General I/O	Low-voltage relay	DALI	KNX	DMX512	EnOcean
controlCUE-versatile	1	1	1	3			8						
controlCUE-one	1		1		2	4		4	2				
controlCUE-two	1		1		6	8		8	4				
controlCUE-versatile-d	1	1	1	3			8						
controlCUE-dali-d	1	1	1	1			4			1			
controlCUE-knx-d	1	1	1	1			4				1		
controlCUE-dmx-d	1	1	1	1			4					2	
controlCUE-enocean-d	1	1	1	1			4						1
smartCUE-relay	1	1	1	3			6		6				
smartCUE-versatile	1	1	1	3			8						
smartCUE-versatile-d	1	1	1	3			8						

PWR IN

Overview

The unit requires power 24 VDC from an external power supply. Use any unit only with the power adapter supplied in the product package. Using another power supply may damage the unit.

Power consumption

Tabletop controllers	
controlCUE-versatile	max. 4 W
controlCUE-one	max. 4 W
controlCUE-two	max. 4 W

DIN-rail controllers	
controlCUE-versatile-d	max. 4 W
controlCUE-dali-d	max. 4 W
controlCUE-knx-d	max. 4 W
controlCUE-dmx-d	max. 4 W
controlCUE-enocean-d	max. 4 W

Lightweight controllers	
smartCUE-relay	max. 4 W
smartCUE-versatile	max. 4 W
smartCUE-versatile-d	max. 4 W

Connector Pin Out

PWR IN		
2-pin 3.5 mm	Pin	Description
	+	Power +24 VDC
	G	Ground

Tabletop Models

The standard power adapter is delivered with the unit. Attach the 2-pin connector of the power supply unit to the PWR IN connector located on the rear panel and attach power cable to a power outlet.

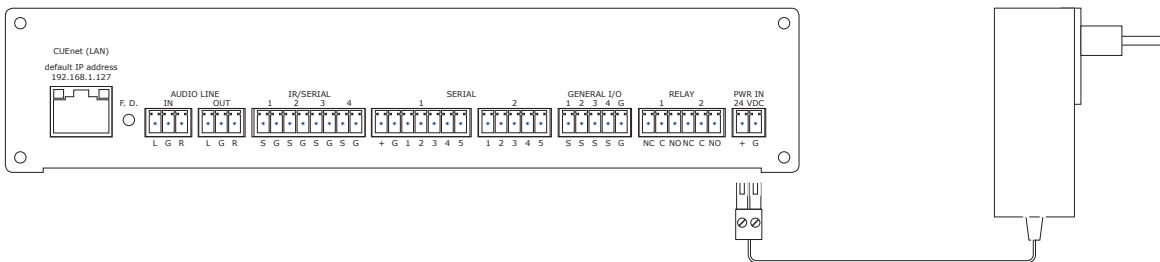

DIN Rail Models

The DIN rail compatible power supply is delivered with all DIN rail controllers.

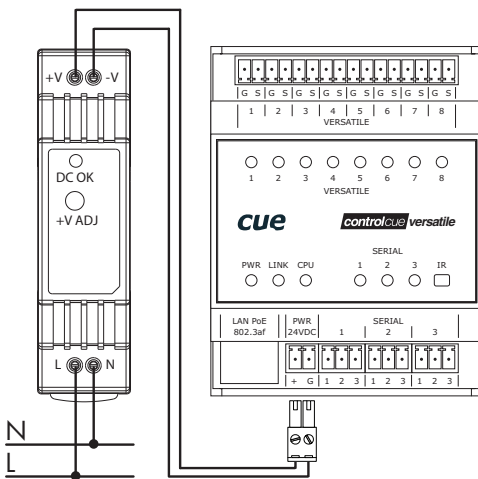

Power over Ethernet

All controllers equipped with PoE are compatible with standard IEEE 802.3af / Class 0.

Ethernet with PoE Infrastructure

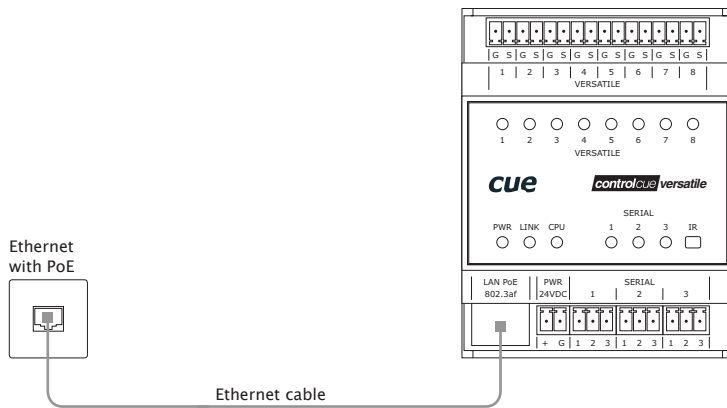

Ethernet without PoE Infrastructure

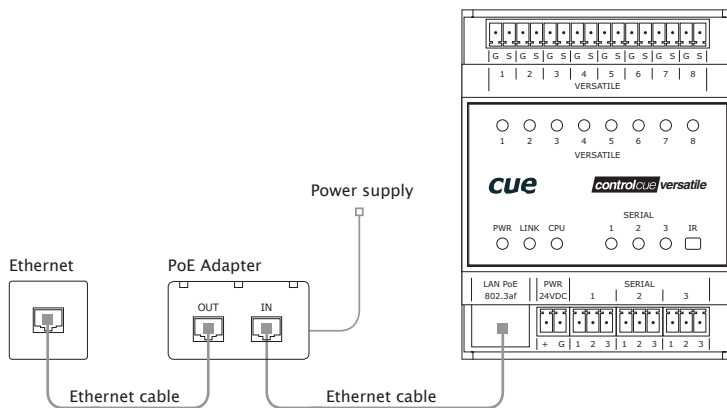

CUEnet (LAN)

10/100 BaseT LAN Connector

The 10/100 BaseT LAN is a standard network connection 10/100 BaseT LAN using RJ-45 connector.

The length of the Ethernet cable connecting controller to the network must not exceed 100 meters.

Connector pin out

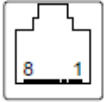
RJ-45	Pin	Signal	Cat5 Cable Color
	1	TX_D1+ and PoE	White / Orange
	2	TX_D1- and PoE	Orange
	3	RX_D2+ and PoE	White / Green
	4		Blue
	5		White / Blue
	6	RX-D2- and PoE	Green
	7		White / Brown
	8		Brown

Direct PC Connection

Attach one end of an RJ-45 Ethernet cable to the CUEnet (LAN) port and attach the other end of the RJ-45 Ethernet cable to your computer. Use straight-through cable if your PC supports autosense or crossed-over cable if your PC doesn't support autosense.

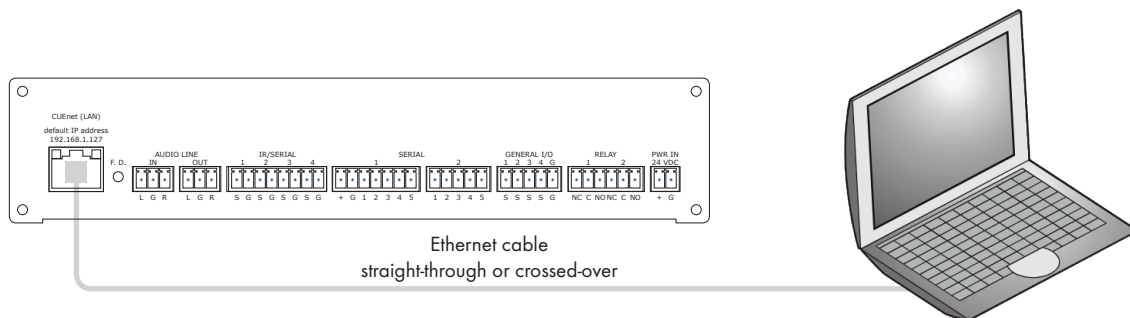

LAN Network Connection

Attach one end of an RJ-45 Ethernet straight-through cable to the CUEnet (LAN) port and attach the other end of the RJ-45 Ethernet cable to your computer.

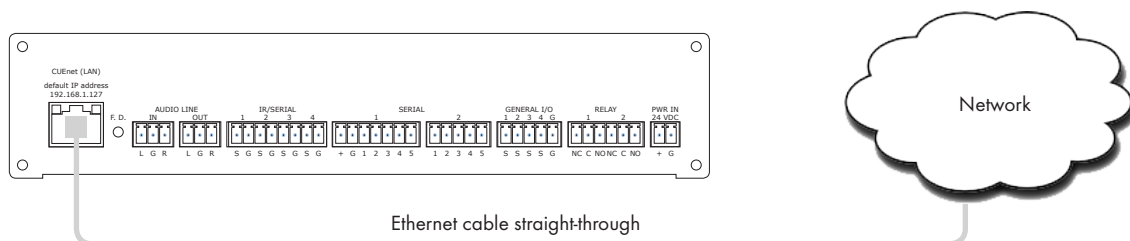

Windows Local Network Settings

For Windows 7 steps are

1. Start Windows 7.
2. Click Start.
3. Enter ncpa.cpl to the Search Box and press Enter. Following window is displayed.

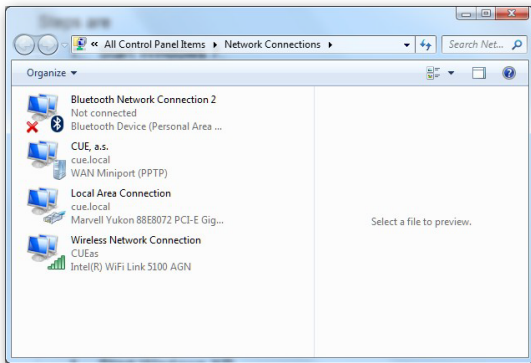

For Windows XP steps are

1. Start Windows XP.
2. Click Start, then click Control Panel choose the option to switch to Classic View.
3. Double-click Network Connections.

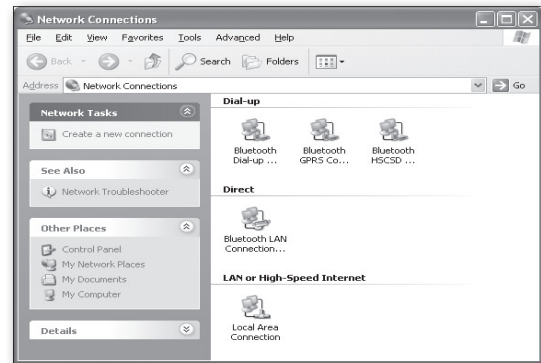

Following steps are

1. Right-click on network adapter used for connection with controller and then right-click and select Properties.
2. Select Internet Protocol (TCP/IP) and click Properties button.
3. Select Use the following IP address option. Set IP address to 192.168.1.1 (or other address different from 192.168.1.127 and from 192.168.1.128) and Subnet mask to 255.255.255.0. Leave other options unchanged and click OK.

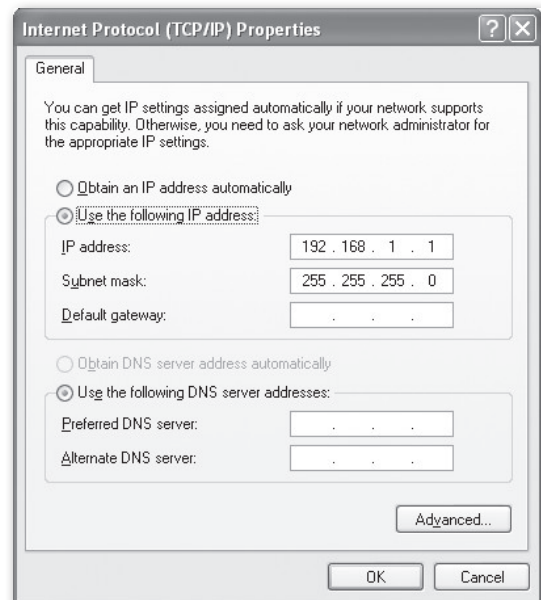
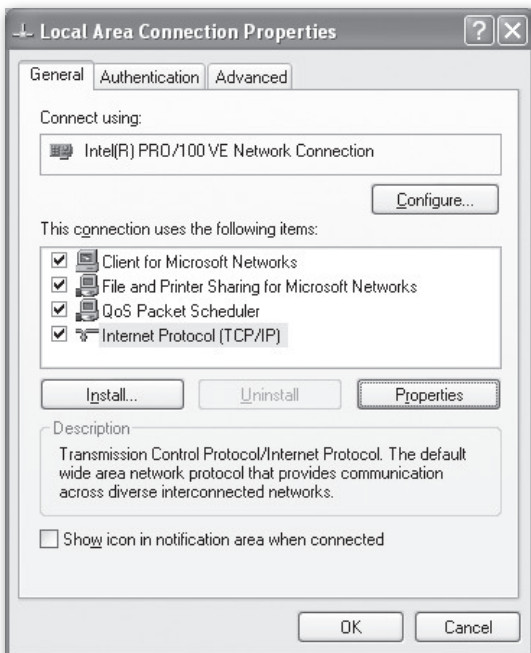

SERIAL

Overview

Unit	Serial port		
	Serial RS-232/485	Serial RS-232/422/485	Serial RS-232/422/485 with power 24 VDC
controlCUE-versatile	3		
controlCUE-one		1	1
controlCUE-two		5	1
controlCUE-versatile-d	3		
controlCUE-dali-d	1		
controlCUE-knx-d	1		
controlCUE-dmx-d	1		
controlCUE-enocean-d	1		

Unit	Serial port
smartCUE-versatile	3
smartCUE-versatile-d	3
smartCUE-relay	3

Bi-directional Serial RS-232/485

Overview

These bi-directional serial channels are used for RS-232 and RS-485 communication. Maximum speed is 115 200 Bd (bps). Default mode for all channels is RS-232, other modes must be set in programming application. For more details see programming manuals.

RS-232 Mode

Output signal levels for RS-232 are in the -10 V to +10 V range. This is default mode for all channels.

SERIAL RS-232				
3-pin 3.5 mm	Pin	Signal	Description	Direction
	1	TxD	RS-232 Transmitted Data	From controller
	2	RxD	RS-232 Received Data	To controller
	3	GND	Ground	

RS-485 Mode

This mode must be set in the programming application.

SERIAL RS-485			
3-pin 3.5 mm	Pin	Signal	Description
	1	A+	RS-485 Data +
	2	B-	RS-485 Data -
	3	GND	Ground

Bi-directional Serial RS-232/422/485

Overview

These bi-directional serial channels are used for RS-232, RS-422 and RS-485 communication. Maximum speed is 115 200 Bd (bps). Default mode for all channels is RS-232, other modes must be set in programming application. For more details see programming manuals.

RS-232 Mode

Output signal levels for RS-232 are in the -10 V to +10 V range. This is default mode for all channels.

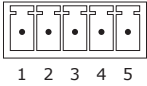
SERIAL RS-232				
5-pin 3.5 mm	Pin	Signal	Description	Direction
	1	TxD	RS-232 Transmitted Data	From controller
	2	RTS	RS-232 Request to Send	From controller
	3	GND	Ground	
	4	RxD	RS-232 Received Data	To controller
	5	CTS	RS-232 Clear to Send	To controller

RS-422 Mode

This mode must be set in the programming application.

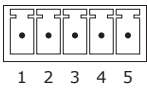
SERIAL RS-422				
5-pin 3.5 mm	Pin	Signal	Description	Direction
	1	Tx A+	RS-422 Transmit Data (Idles High)	From controller
	2	Tx B-	RS-422 Transmit Data (Idles Low)	From controller
	3	GND	Ground	
	4	Rx A+	RS-422 Receive Data (Idles High)	To controller
	5	Rx B-	RS-422 Receive Data (Idles Low)	To controller

RS-485 Mode

This mode must be set in the programming application.

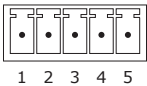
SERIAL RS-485				
5-pin 3.5 mm	Pin	Signal	Description	
	1	A+	RS-485 Data +	
	2	B-	RS-485 Data -	
	3	GND	Ground	
	4	N.C.	Not Connected	
	5	N.C.	Not Connected	

Bi-directional Serial RS-232/422/485 with Power 24 VDC

Overview

This bi-directional serial channel is used for RS-232, RS-422 and RS-485 communication and for power supply 24 VDC and it is applicable as SERIAL 1. Maximum speed is 115 200 Bd (bps). Default mode for all channels is RS-232, other modes must be set in programming application. For more details see programming manuals.

RS-232 Mode

Output signal levels for RS-232 are in the -10 V to +10 V range. This is default mode.

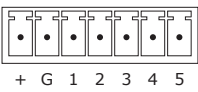
RS-232 with power 24 VDC				
7-pin 3.5 mm	Pin	Signal	Description	Direction
	+24	+24	Power +24 VDC	
	G	GND	Ground	
	1	TxD	RS-232 Transmitted Data	From controller
	2	RTS	RS-232 Request to Send	From controller
	3	GND	Ground	
	4	RxD	RS-232 Received Data	To controller
	5	CTS	RS-232 Clear to Send	To controller

RS-422 Mode

This mode must be set in the programming application.

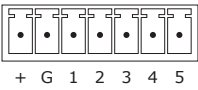
RS-422 with power 24 VDC				
7-pin 3.5 mm	Pin	Signal	Description	Direction
	+24	+24	Power +24 VDC	
	G	GND	Ground	
	1	Tx A+	RS-422 Transmit Data (Idles High)	From controller
	2	Tx B-	RS-422 Transmit Data (Idles Low)	From controller
	3	GND	Ground	
	4	Rx A+	RS-422 Receive Data (Idles High)	To controller
	5	Rx B-	RS-422 Receive Data (Idles Low)	To controller

RS-485 Mode (CUEwire)

This mode is suitable for connection of CUEwire devices and it must be set in the programming application. This mode can be also used for general RS-485 communication and must be set in the programming application.

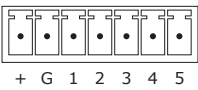
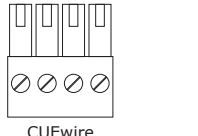
SERIAL RS-485				
5-pin 3.5 mm	Pin	Signal	Description	
 	+24	+24	Power +24 VDC	
	G	GND	Ground	
	1	A+	RS-485 Data +	
	2	B-	RS-485 Data -	
	3	GND	Ground	
	4	N.C.	Not Connected	
	5	N.C.	Not Connected	

VERSATILE

Overview

Depending on the application, the versatile port can be used in multiple ways as described in the following table.

Input modes	
Digital input	Adjustable threshold <ul style="list-style-type: none"> High sensitivity - binary 0 < 1.45 V, binary 1 > 2.05 V Low sensitivity - binary 0 < 5.8 V, binary 1 > 8.2 V Input impedance >100 kΩ Adjustable digital filter
Pulse counter	Adjustable threshold as above Input impedance as above Pulse length min. 1 ms, max. frequency 500 Hz Max. number of pulses 2 147 483 647 (Long) Adjustable digital filter
Voltage input	Range 0 ÷ 2.5 VDC, 0 ÷ 10 VDC, auto Input impedance >100 kΩ Resolution 12-bit Adjustable digital filter Accuracy ±0.1 % of reading, ±0.1 % of range (0.1 ÷ 10 V, digital filter applied)
Resistance input	Range 2 kΩ, 20 kΩ, 200 kΩ, auto Resolution 12-bit Adjustable digital filter Accuracy (digital filter applied) <ul style="list-style-type: none"> 100 Ω ÷ 800 Ω: ±3 % of reading, ±0.1 % of range 800 Ω ÷ 20 kΩ: ±0.3 % of reading, ±0.1 % of range 20 kΩ ÷ 200 kΩ: ±1 % of reading, ±0.1 % of range
Output modes	
Digital output	Max. sink current 200 mA / max. 30 VDC Catch diodes for use with real load
Current pullup	Current-source pull-up 10 mA / max. 12 V
Current pulldown	Current-source pull-down -10 mA / max. -12 V
IR output	Maximum IR carrier frequency 500 kHz Up to 3 original IR Adapter /i in parallel
Serial output	RS-232 Serial data baud rate 300 Bd ÷ 115 200 Bd (bps)

Warnings

- The port is protected to maximum 30 VDC. Exceeding this voltage may damage the port.
- Incorrect wiring may damage the versatile port or the connected device.
- All versatile ports in the unit have common ground which is connected to the grounds of other control ports. That means versatile ports are not isolated from other control ports.

Connector pin out

2-pin 3.5 mm	Pin	Signal	Description
	S	Signal	Versatile port signal (input/output)
	G	GND	Ground

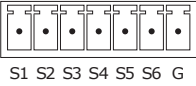
7-pin 3.5 mm	Pin	Signal	Description
	S1 - S6	Signal	Versatile port signal (input/output)
	G	GND	Ground

Digital Input

Every versatile port can be used as digital input for contacts, buttons, sensors etc. For digital input usage the output has to be in an open state and current pull-up and current pull-down can be used.

Parameters of pulse counter input are as follows:

- Adjustable threshold
 - High sensitivity - binary 0 < 1.45 V, binary 1 > 2.05 V
 - Low sensitivity - binary 0 < 5.8 V, binary 1 > 8.2 V
- Input impedance >100 kΩ
- Adjustable digital filter

The port offers adjustable threshold as described in the following picture.

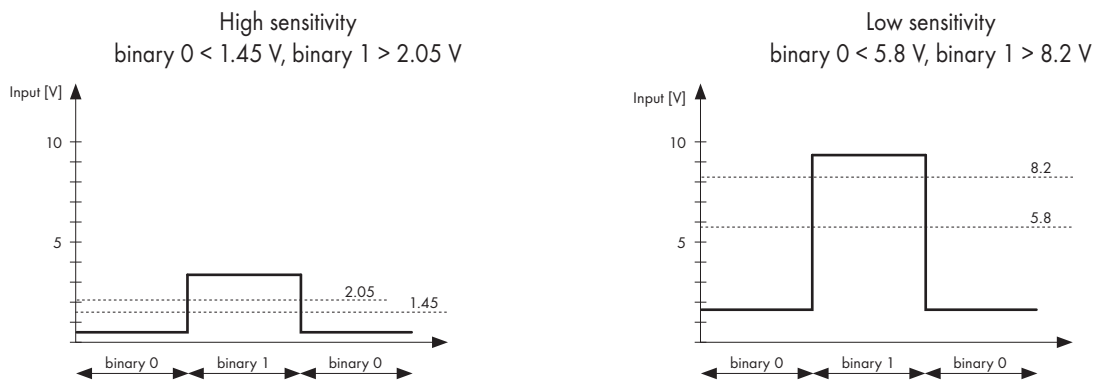

The following table describes how to use digital input.

Detecting a pushbutton or contact

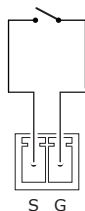

Any button or contact closure can be connected.

Pulse Counter

Parameters of pulse counter input are as follows:

- Adjustable threshold as above
- Input impedance as above
- Pulse length min. 1 ms, max. frequency 500 Hz
- Max. number of pulses 2 147 483 647 (Long)
- Adjustable digital filter

The following table describes how to use pulse counter input.

Energy meters S0 interface pulse counter

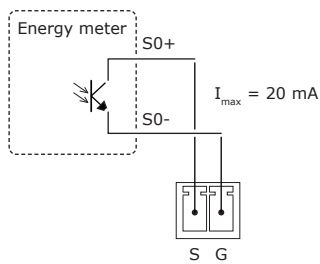

Many meters have pulse outputs, including electricity meters (single phase, 3-phase), gas meters, water flow meters, etc. In the case of an electricity meter a pulse output corresponds to a certain amount of energy passing through the meter (kWhr/Whr). For single-phase domestic electricity meters each pulse usually corresponds to 1 Whr (1000 pulses per kWhr). In the case of higher power meters (often three-phase), each pulse corresponds to a greater amount of energy eg. 2 Whr per pulse or even 10 Whr per pulse.

Pulse outputs from third-party energy meters. S0 interface defines a simple galvanically isolated open-collector output channel.

Voltage Input

Parameters of voltage input are as follows:

- Range 0 ÷ 2.5 VDC, 0 ÷ 10 VDC, auto
- Input impedance >100 kΩ
- Resolution 12-bit
- Adjustable digital filter
- Accuracy ±0.1 % of reading, ±0.1 % of range (0.1 ÷ 10 V, digital filter applied).

The following table describes how to use voltage input.

Detecting a voltage

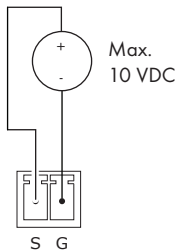

Sensors with voltage output 0 - 10 VDC

Reading voltage

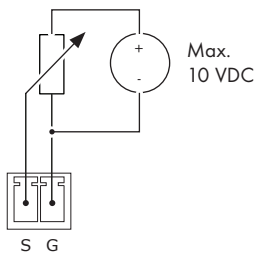

Potentiometer with external power supply

Resistance Input

Parameters of resistance input are as follows:

- Range 2 k Ω , 20 k Ω , 200 k Ω , auto
- Resolution 12-bit
- Adjustable digital filter
- Accuracy (digital filter applied)
 - 100 Ω ÷ 800 Ω : ± 3 % of reading, ± 0.1 % of range
 - 800 Ω ÷ 20 k Ω : ± 0.3 % of reading, ± 0.1 % of range
 - 20 k Ω ÷ 200 k Ω : ± 1 % of reading, ± 0.1 % of range

The following table describes how to use resistance input.

Reading resistance

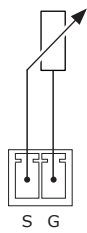

100 Ω ÷ 200 k Ω

Potentiometer for light, temperature and volume control.

Temperature sensors

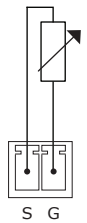

100 Ω ÷ 200 k Ω

Thermistors and temperature sensors as Pt1000, Ni1000, NTC 12k, KTY 81-121. etc. can be connected.

Current Loop Receiver

For current loop input, it is necessary use Current Loop Adapter, CS0479. This adapter contains resistor 120 Ω and allows measure current 0/4 ÷ 20 mA using voltage detection.

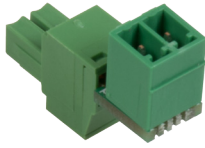

The following picture describes current loop input connection.

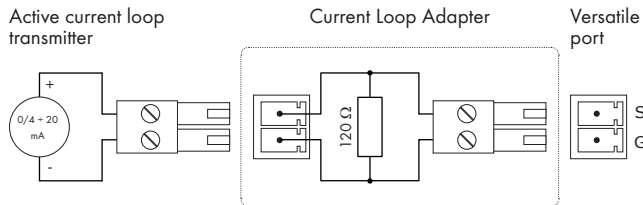

Description

- For current loop range 0/4 ÷ 20 mA, the versatile port has to be set to voltage input mode, range 0 ÷ 2.5 VDC.
- $I_{\text{currentloop}} = U_{\text{detected}} / 0.120$

Voltage [V]	0,00	0,12	0,24	0,36	0,48	0,60	0,72	0,84	0,96	1,08	1,20	1,32	1,44	1,56	1,68	1,80	1,92	2,04	2,16	2,28	2,40
Current [mA]	0,00	1,00	2,00	3,00	4,00	5,00	6,00	7,00	8,00	9,00	10,00	11,00	12,00	13,00	14,00	15,00	16,00	17,00	18,00	19,00	20,00

- Versatile port pin G is connected to controller ground.

Digital Output

For digital output the open collector switch is used. Parameters of digital output are as follows:

- Max. sink current 200 mA / max. 30 VDC
- Catch diodes for use with real load

The following table describes how to use digital output.

Driving a relay coil

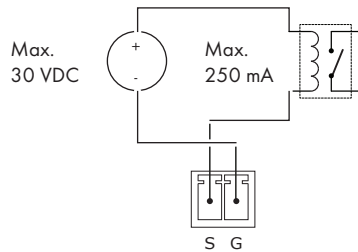

Driving relays with low-voltage coil

Driving LED strip

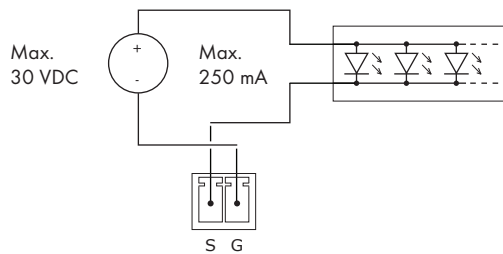

Driving LED strips with max. voltage 30 VDC and max. current 200 mA.

Current Pull-up / Pull-down

For digital output the current pull-up or pull-down can be used.

Parameters of the current pull-up are as follows:

- Current-source pull-up constant 10 mA
- Max. voltage limited to 12 V.

Parameters of the current pull-down are as follows:

- Current-source pull-down constant -10 mA
- Max. voltage limited to -12 V.

The following table describes how to use pull-up and pull-down output.

Driving LED indicator

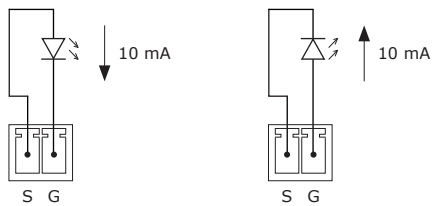

Driving LEDs for custom indicators on keyboards, control panels, etc. Brightness can be controlled using PWM.

Driving bi-color LED indicator

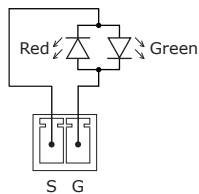

Driving bi-color LED indicator. Color and brightness can be controlled using PWM.

IR Output

This mode of versatile port provides output for infra-red emitters IR Adapter /i. Parameters of IR output are as follows:

- Maximum IR carrier frequency 500 kHz
- Up to three original infra-red emitters IR Adapter /i can be connected to each output in parallel. All emitters send the same IR codes. This configuration can be used for different types of devices.

Warning

- It is not recommended to connect more infra-red emitters of various manufacturers in parallel because the output can be either overloaded or damaged.

Connecting

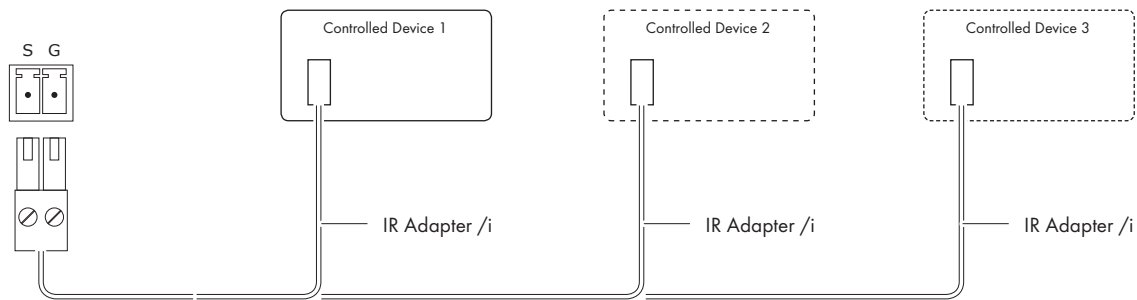

Serial Output

This mode provides one-way RS-232 output channel.

Parameters of serial output are as follows:

- RS-232 mode only
- Serial data baud rate 300 Bd ÷ 115 200 Bd (bps)

Warnings

- In case there are more ports in the unit, all pins labelled G are connected together.

Connecting

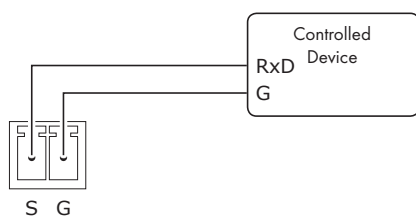

IR/SERIAL

This type of port provides:

- Output for infra-red emitters (IR Adapter /i, IR Sprayer), maximum IR output rate is 1.2 MHz.
- RS-232 serial output (one way), maximum serial data rate is 115 200 Bd (bps), output signal levels for RS-232 are in the -12 V to +12 V range.

The IR outputs and RS-232 outputs can be combined on independent outputs (for example three outputs can be used as IR, five outputs can be used as RS-232).

IR/SERIAL			
2-pin 3.5 mm	Pin	Signal	Description
	S	Signal	IR/Serial Signal (Output)
	G	GND	Ground

Notes

- All pins labelled G are connected together.
- Up to three original infra-red emitters IR Adapter /i can be connected to each output in parallel.
- Up to ten IR Sprayers can be connected to each output in parallel
- It is not recommended to connect more infra-red emitters of various manufacturers in parallel because the output can be either overloaded or damaged.

GENERAL I/O

General I/O provides analog input as well as digital output. Each General I/O port can be used either as input or as output.

Pull-up resistor 680 ohms is connected to +5 VDC and can be switched on and off for each I/O independently. I/O voltage with pull-up on is approx. +4.3 VDC, because protection diode is connected in series (0.7 V dropdown).

Analog input is rated 0 - 5 VDC. Analog to digital (A/D) converter has 10-bits precision (i.e. 1024 levels).

Digital output can switch max. 24 VDC / 80 mA. Output voltage for output switch on is approx. 0.6 V.

I/O schematic diagram

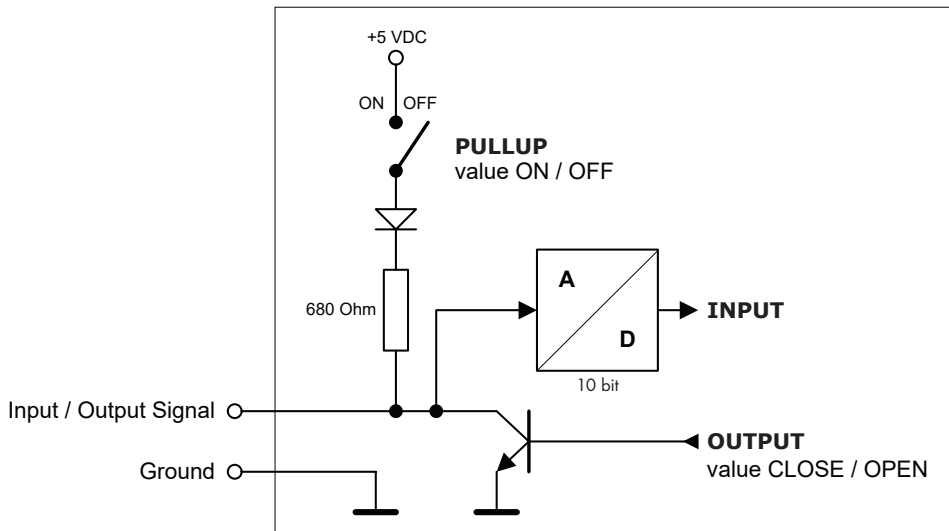

Connector pin out

GENERAL I/O			
5-pin 3.5 mm	Pin	Signal	Description
	S	Signal	Input / Output Signal 1 - 4 (5 - 8)
	G	GND	Common ground for all I/Os

RELAY

This port provides one isolated low voltage relay. Each relay contact closure is rated 24 V / 0.5 A.

Normally Close (NC) and Normally Open (NO) contacts as well as Common (C) contact of each relay can be used. The Normally Close (NC) position is the state of the relay when it is not turned on (energized).

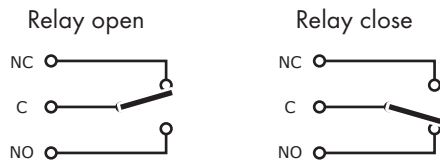

Connector pin out

RELAY		
3-pin 3.5 mm	Pin	Description
	NC	Relay Contact Normally Close
	C	Relay Contact Common
	NO	Relay Contact Normally Open

AUDIO LINE

IN

This connector provides unbalanced line level audio.

Connector pin out

AUDIO LINE IN			
3-pin 3.5 mm	Pin	Signal	Description
	L	Left	Left channel input
	G	GND	Ground
	R	Right	Right channel input

OUT

This connector provides un-amplified unbalanced line level audio. Connect audio devices, such as an audio amplifier or powered speakers to this connector.

Connector pin out

AUDIO LINE OUT			
3-pin 3.5 mm	Pin	Signal	Description
	L	Left	Left channel output
	G	GND	Ground
	R	Right	Right channel output

DALI

This galvanically isolated port provides connection to DALI (Digital Addressable Lighting Interface). The port does not provide DALI power supply which must be ensured by external DALI power source. DALI units are equipped with a diode bridge so that devices can be wired regardless of the cable polarity.

DALI is a data protocol and transport mechanism that was jointly developed and specified by several manufacturers of lighting equipment. The DALI standard is specified in the 60929 IEC standard. The DALI protocol allows for the maximum of 64 fittings on a single network and the network can be divided into up to 16 different possible areas.

Connection is provided by pluggable terminal block 2 x 4 push-wire connection, AWG 18-22.

Connector pin-out

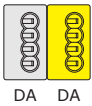
Terminal block 2 x 4	Pin	Description
 DA DA	DA	DALI signal
	DA	DALI signal

Connecting

DALI is connected to controlCUE-dali-d control port as described below. No need to worry about polarity.

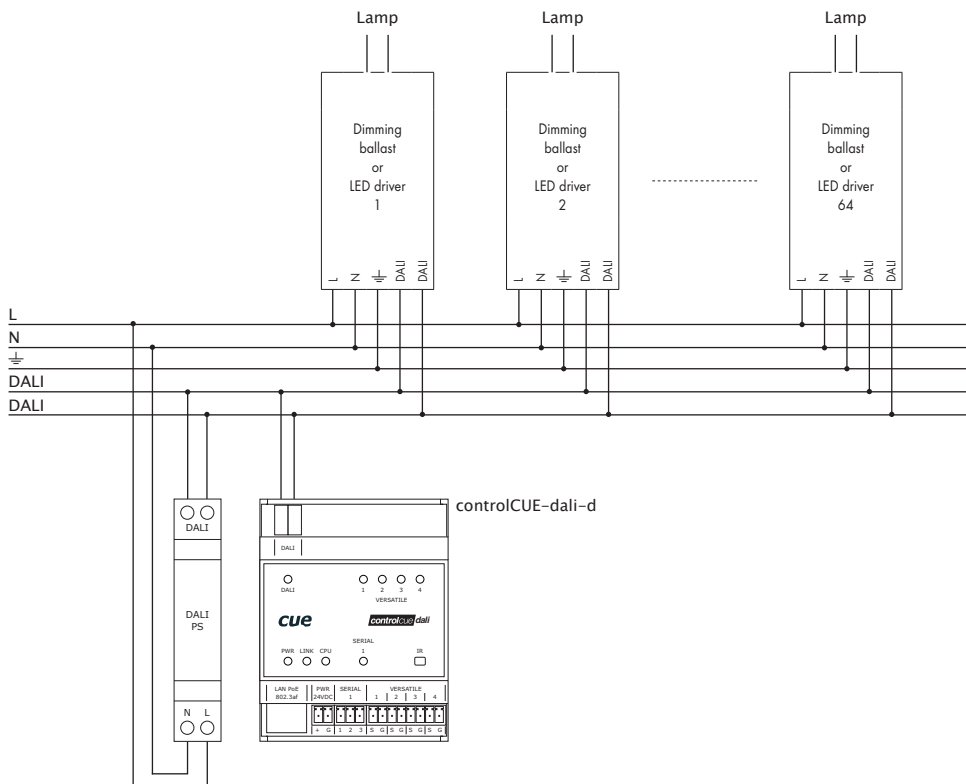

Note

The controlCUE-dali-d controller does not provide DALI power supply. As described in the picture above it is necessary to use external DALI power supply.

KNX

This galvanically isolated port provides connection to the KNX bus. KNX is a standardized (EN 50090, ISO/IEC 14543), Open Systems Interconnection based network communications protocol for intelligent buildings.

Power consumption from KNX bus is max. 4 mA at 24 VDC and connection is provided by pluggable terminal block 2 x 4 push-wire connection, AWG 18-22.

Connector pin-out

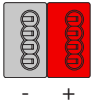
Terminal block 2 x 4	Pin	Description
	-	KNX bus -
	+	KNX bus +

Connecting

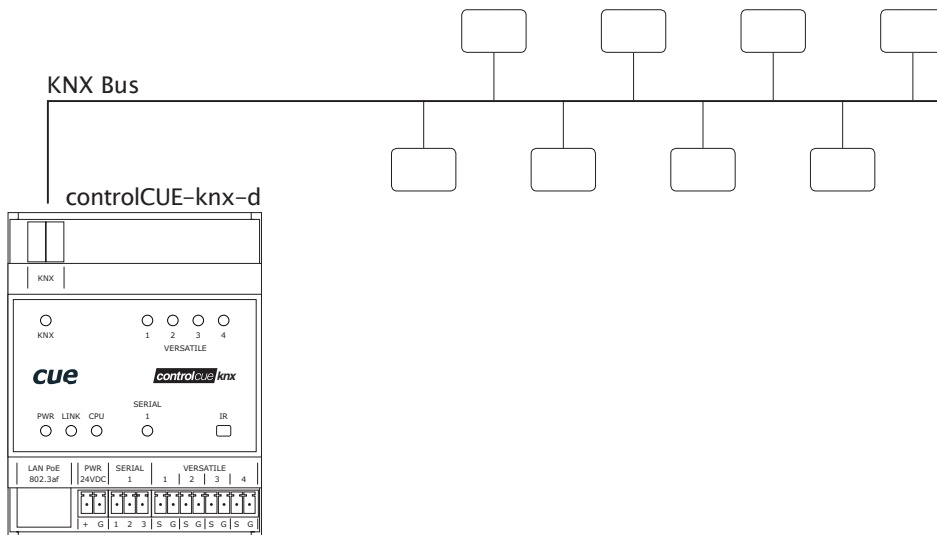

Note

The controlCUE-knx-d controller does not provide KNX power supply. It is necessary to use external KNX power supply.

DMX

DMX512 (Digital MultipleX) is a standard for digital communication networks that are commonly used to control stage lighting and effects as well as interior and architectural lighting. DMX512 employs EIA-485 differential signalling at its physical layer, in conjunction with a variable-size, packet-based communication protocol. It is unidirectional.

The controller equipped with DX512 input and output ports can work in three basic modes.

1. The unit is the master control unit of the DMX512 bus. Only DMX output of the unit is functional in this mode.
2. This mode is useful if there is some master controller of the DMX512 bus, for example a stage console. In this mode it is possible to use the unit to read the levels of particular channels pushed from the DMX512 control console to the DMX input, change it and send the new values to the lights.
3. This mode can be used in the same hardware configuration as in Mode 2, but in this case the unit only re-sends commands from the master DMX console unchanged to the DMX output.

Each DMX512 port can be used as input or as output port.

Connector pin-out

3-pin 3.5 mm	Pin	Description
 D+ D- C	D+	Data +
	D-	Data -
	C	Signal Common

Connecting

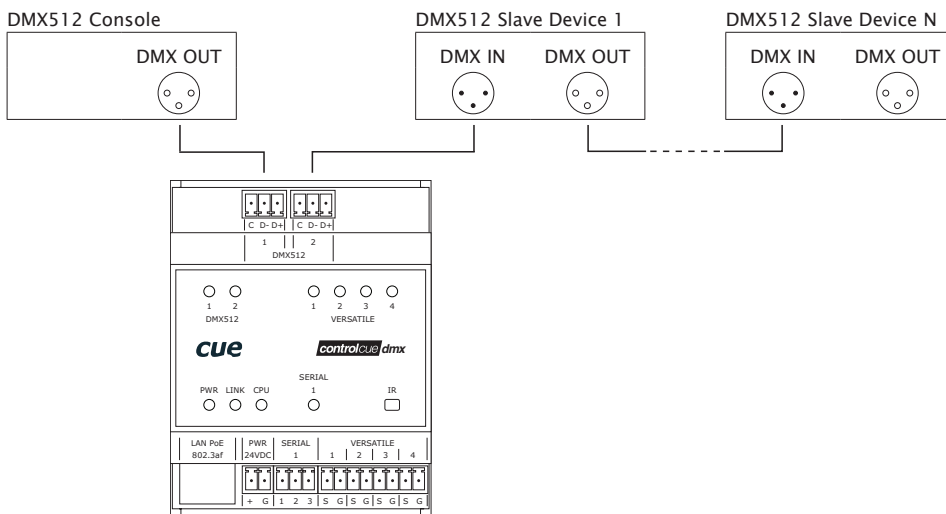

EnOcean

Bi-directional monitoring and control of EnOcean® networks can be provided from IP network. EnOcean® wireless standard offers many of switching and dimming receivers, receivers for blinds, wall mounted and mobile transmitters, input and temperature transmitters, infra passive switches, sensors etc.

Parameters of EnOcean control port are as follows:

- 868 MHz for Europe and countries adopting R&TTE specification
- EnOcean® Equipment Profiles supported
 - EEP A5-07-01 Transmitter
 - EEP A5-30-02 Transmitter
 - EEP A5-30-xx Listener
 - EEP D2-01-03 Listener, EEP D2-01-03 Transmitter
 - EEP D5-00-01 Listener, EEP D5-00-01 Transmitter
 - EEP F6-02-xx Listener, EEP F6-02-xx Transmitter

The unit is delivered with EnOcean® external antenna. Magnetic base enables easy and quick installation. The antenna is connected to the unit using SMA plug. Antenna cable length is 2.5 m.

For more details about EnOcean programming see CVC Help, sections

- Commands / Channels / EnOcean
- CUEdevices / EnOcean.

Connecting

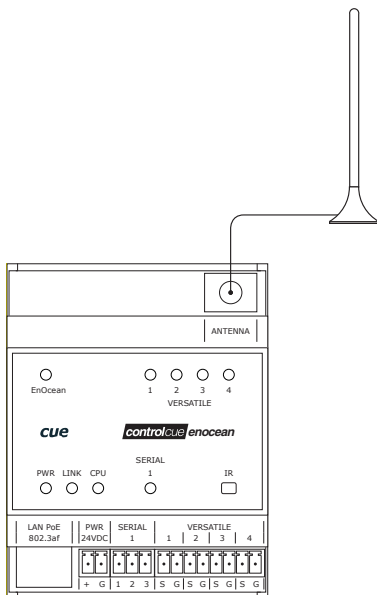

CUEwire Device Connection

All controllers are compatible with CUEwire devices as keyboards, keypads, sensors etc.

Serial port SERIAL 1 in mode RS-485 can be used for CUEwire connection as described on picture below. This port is equipped with 24 VDC output for CUEwire devices power supply.

All other serial ports SERIAL x can be used for CUEwire connection too, but they aren't equipped with 24 VDC output. That means CUEwire devices must be powered externally.

See following figure for CUEwire device connection.

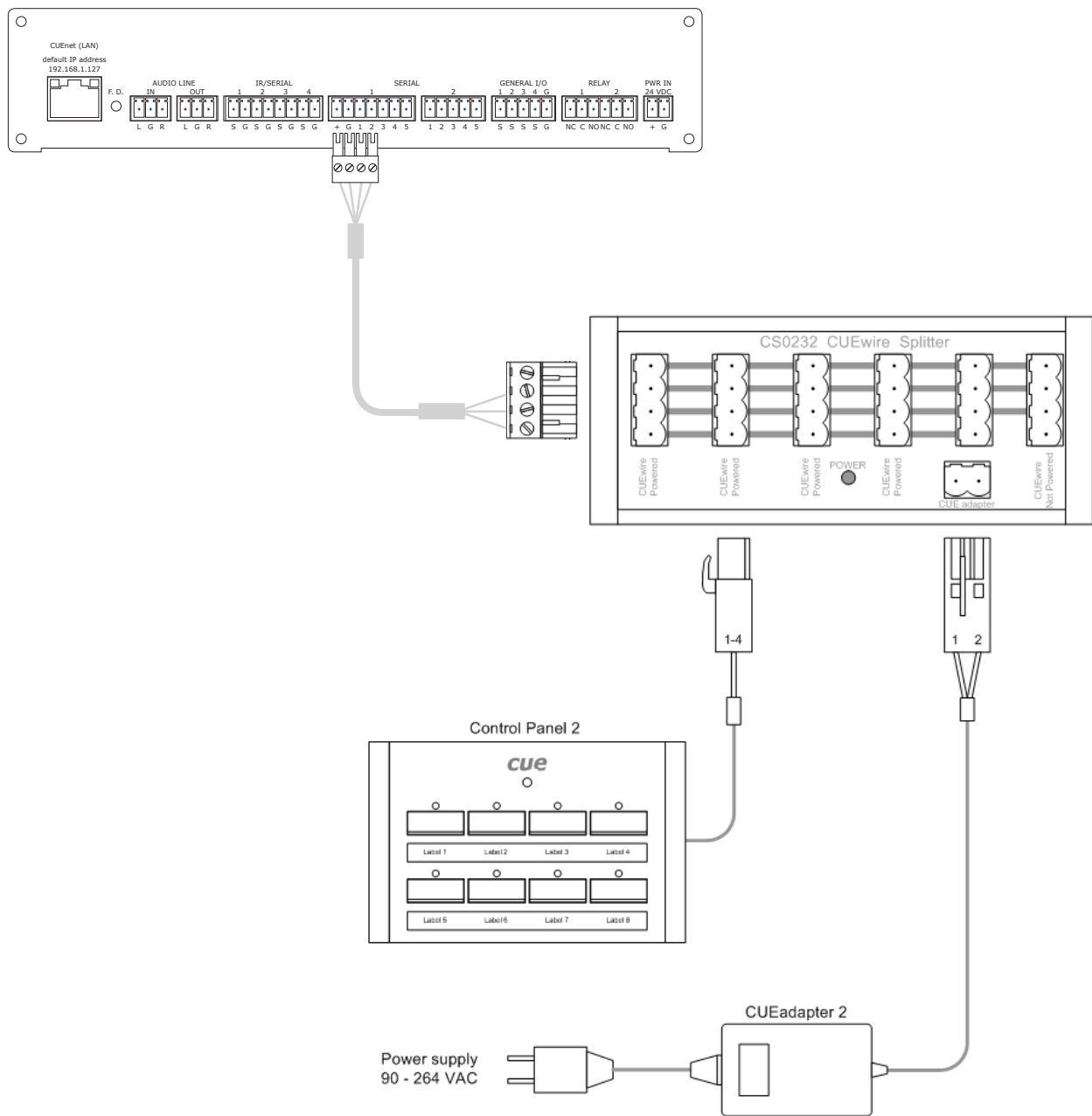

Upload User Application

Overview

User application is dedicated to control and it is programmed by Cue Visual Composer programming tools.

Using Cue Visual Composer

Steps are

1. Connect controller to your computer as described in chapter Connecting / CUEnet (LAN).
2. Run Cue Visual Composer on your PC.
3. Open project in Cue Visual Composer. It's necessary to have appropriate controller properly inserted and configured.
4. Use tool bar button Final to open Upload and Export Application dialog box.
5. Be sure your controller is checked.

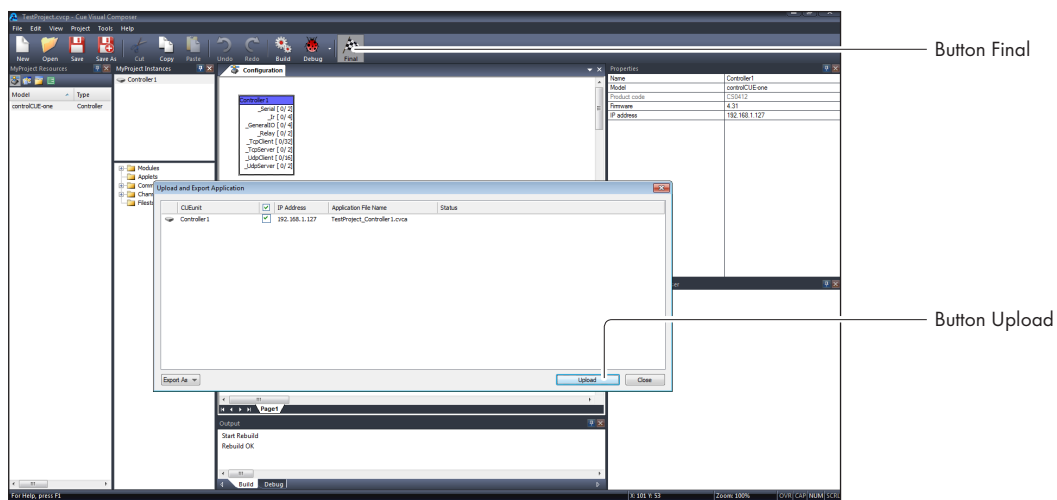

6. Use button Upload to start application upload.
7. If controller firmware isn't actual it will be uploaded automatically first and then application upload will be finished.

Using Admin Web

Steps are

1. Run Cue Visual Composer on your PC.
2. Open project in Cue Visual Composer. It's necessary to have appropriate controller properly inserted and configured.
3. Use tool bar button Final to open Upload and Export Application dialog box.

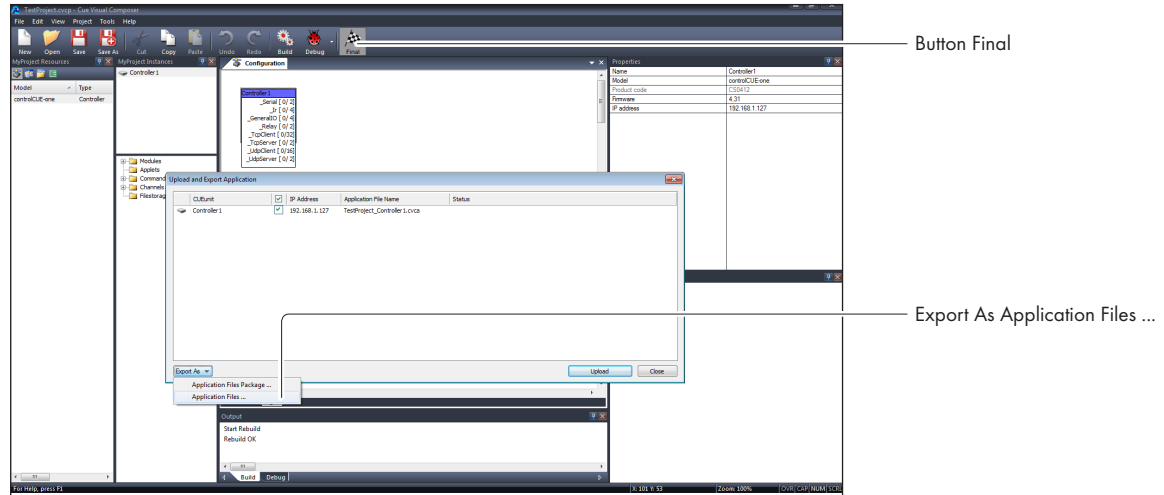

4. Be sure your controller is checked.
5. Use button Export As... and select Application Files ...to export application and store it in file *.cvca.
6. Connect controller to your computer as described in chapter Connecting / CUEnet (LAN).
7. Run the Internet browser on your PC and type in the same controller IP address as you see in Cue Visual Composer project, window Properties / IP address.
8. Admin Web is shown.
9. Go to page System and check current firmware version. In case there is no actual controller firmware version, upload firmware version that corresponds to firmware version in the Cue Visual Composer project.
10. Go to page Applications and upload application file *.cvca.
11. Start uploaded application using button Start.

Admin Web

Access Admin Web

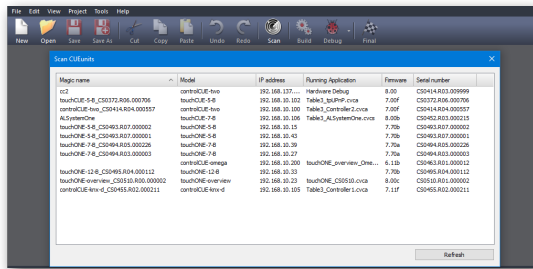

Run the Internet browser on your PC and type in the controller IP address. IP address is obtained from DHCP server by (factory default or it is 192.168.1.127, if DHCP is not available on the network. The default password is empty.. The default password is empty. You can find CUEunits and their IP addresses on the network with Cue Visual Composer / Tools / Scan CUEunits... You can open Internet browser with admin web of given unit by doubleclick on the line with this unit.

Login

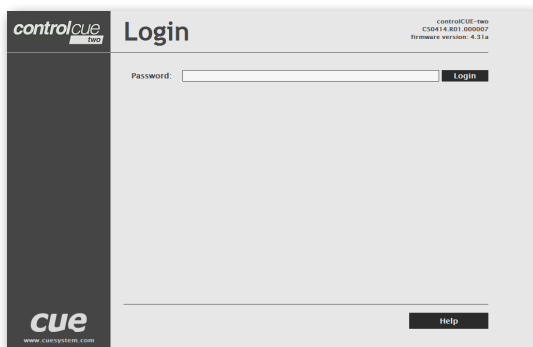

This screen isn't displayed if password is empty (factory default status).

If password isn't empty, you have to login at first for operating with your CUEunit via these web pages.

Enter your password into the Password box and click the Login button to enter the CUEunit web pages.

Remember that the password is case sensitive. For changing your password use the Password menu after you are logged in.

Configuration

Identification

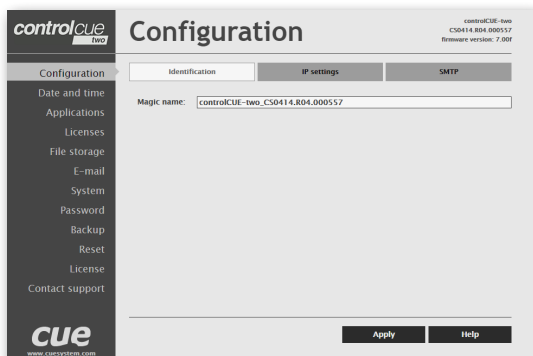

Every CUEunit can be identified by a unique Magic name. Magic names are most useful in applications requiring more than one CUEunit or when CUEunit obtain IP address from DHCP server. This enables programmers and installers to reference CUEunits with logical, user friendly names, like "boardroom," "lobby," etc.

To set the CUEunit identity, enter the unique name you wish to use in the Magic name box.

Be sure to click the Apply button for any changes to become effective!

IP Settings

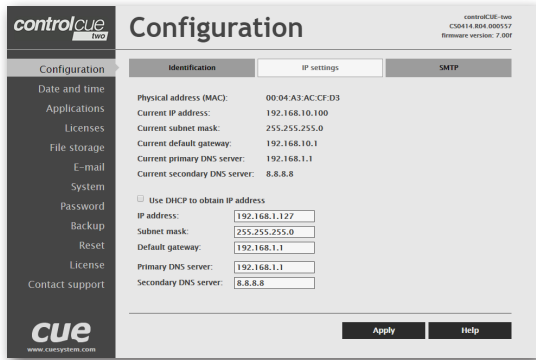

This page is used for establishing the communication parameters for your CUEunit.

The CUEunit uses standard internet protocol (IP) communication parameters. Certain parameters can be reset by the user. On start up, this page will display the CUEunit's given Physical address (MAC), Current IP address, Current primary DNS server and Current secondary DNS Server. Carefully note this address information (and any changes you make to the IP address, subnet mask, default gateway or primary and secondary DNS server). You can also set CUEunit to obtain IP address automatically from DHCP server. For it check the checkbox Use DHCP to obtain IP address. IP address or Magic name must be entered into the Cue Visual Composer program written for your specific application. For control systems with more than one CUEunits, a unique IP address must be given to each CUEunit.

Some control systems are "stand alone" and not part of a larger network. For such "stand alone" systems, the Magic name is optional. However, for control systems that are connected to a larger network, please obtain the Host name from the network administrator, and enter it into the Magic name box.

Be sure to click the Apply button for any changes to become effective!

SMTP

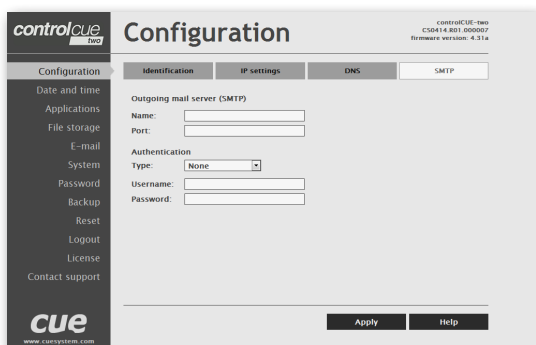

This page is used for setting parameters of SMTP server. Set a name or an address and the port of your SMTP server.

The SMTP server and port are used by the XPL2 commands EmailSend and PresetEmailSend.

Be sure to click the Apply button for any changes to become effective!

Date and Time

Current Date and Time

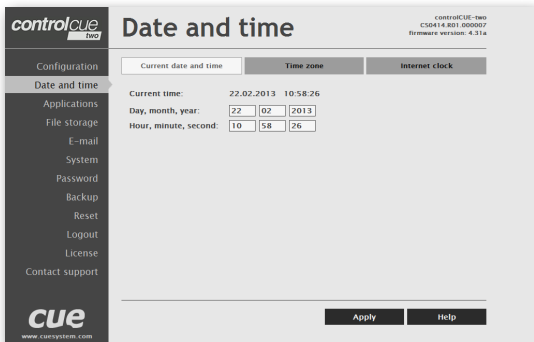

This page is used for setting the time clock on your CUEunit. The current date, time, and time zone are shown on the Current time line.

The applicable boxes can be selected to enter changes to the

- ▪ date: day/month/year,
- ▪ time: hour/minute/second.

Be sure to click the Apply button for any changes to become effective!

Time Zone

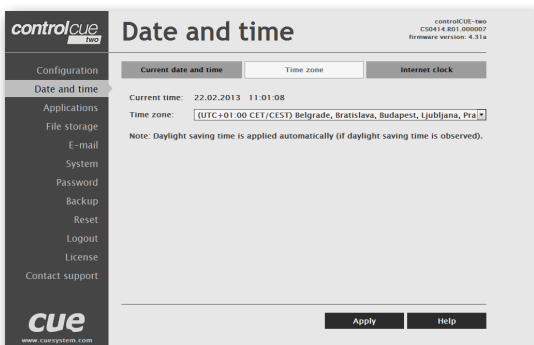

This page is used for setting the time zone on your CUEunit. The current date, time, and time zone, are shown on the Current time line. The time zone box can be selected to enter changes to the Time zone.

Be sure to click the Apply button for any changes to become effective!

Internet Clock

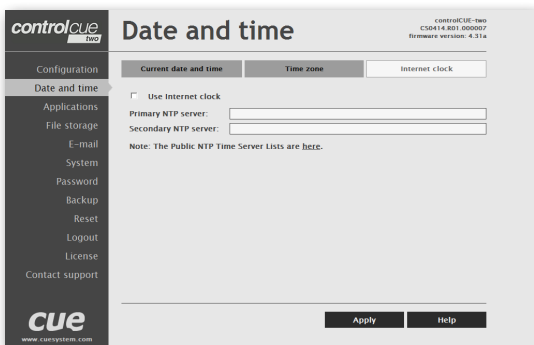

This page is used for synchronization of the CUEunit's date and time with an internet clock. Begin by selecting the check box for Use Internet clock. Next, enter the IP addresses (or complete address name) of the primary and secondary NTP servers. Use the Primary NTP server and Secondary NTP server boxes for this purpose.

Be sure to click the Apply button for any changes to the internet clock to become effective!

Applications

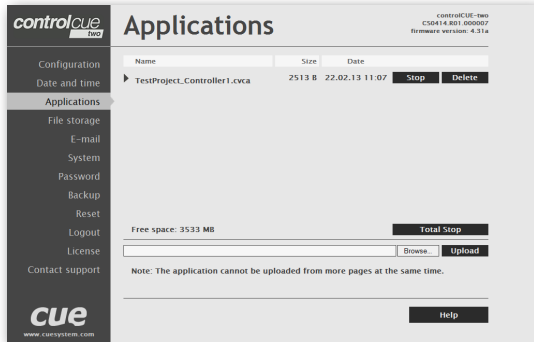

This page is used for uploading compiled Cue Visual Composer programs to your CUEunit.

All uploaded applications are listed on this page, along with their file properties: file name/file size/date. The CUEunit has a generous memory; unused free space is shown at the bottom of this page. CUEunit also permits other service functions like deleting files, downloading programs back to a personal computer, and starting/stopping specific applications.

A “running flag” denotes the active application. The running application can be stopped via the Start/Stop button. Likewise, a stopped application can be restarted with the Start/Stop button.

Files are uploaded from a personal computer to the CUEunit by selecting the desired application program, and clicking the Upload button. Files are downloaded from the CUEunit to a personal computer by clicking the File name. Files are easily deleted with the Delete button. The button Total stop stops a running application. This application will not be automatically started after reset.

File Storage

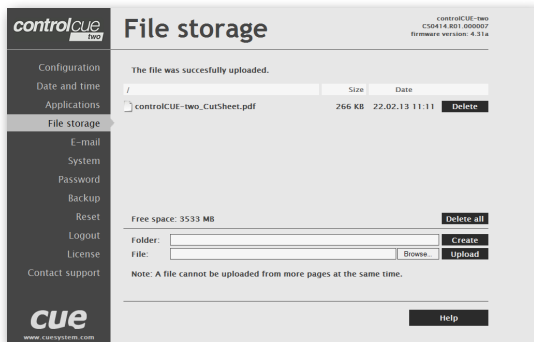

The CUEunit’s generous memory can be used as an auxiliary file storage device. This is helpful for storing presets, in archiving electronic manuals, pdf files, and other support documentation. File storage is managed via the file storage page.

A list of existing files, folders, and their properties is shown. To delete a file or a folder, click the Delete button on the corresponding line. To delete all files and folders from the current folder, click the Delete All button.

To create a new folder, enter a name for the new folder, and click the Create button. To upload a file, select the desired file, and click the Upload button.

Note: Files are automatically compressed for the CUEunit’s internal file system. Accordingly, the size of your uncompressed file before storing may not match the decrease of free space shown on the CUEunit.

E-mail

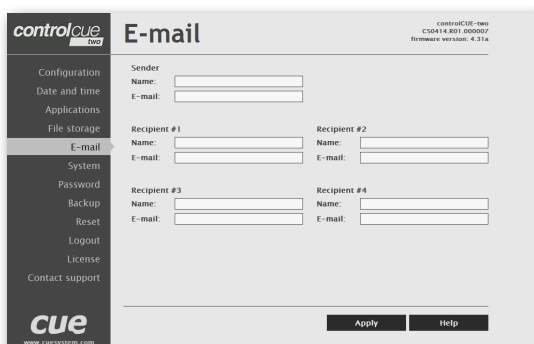

This page is used for setting parameters of e-mail parameters and recipients addresses.

The SMTP server must be set. See the Configuration/SMTP setting.

The sender Name and E-mail are addresses of your CUEunit. The sender Name and E-mail are used by the XPL2 commands EmailSend and PresetEmailSend.

The recipient Names and E-mails are addresses of recipients, where e-mails will be sent using the XPL2 command PresetEmailSend.

System

Firmware

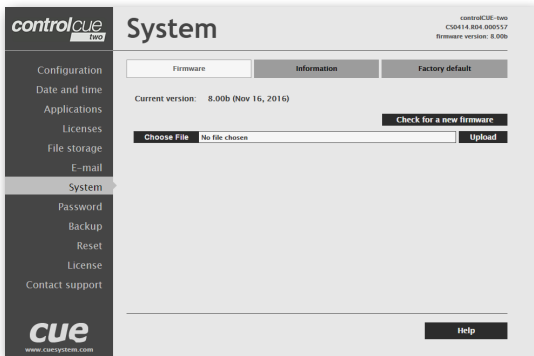

This page is used for updating the CUEunit firmware. The Current version of firmware is shown. To upload new firmware, select the desired version, and click the Upload button.

Information

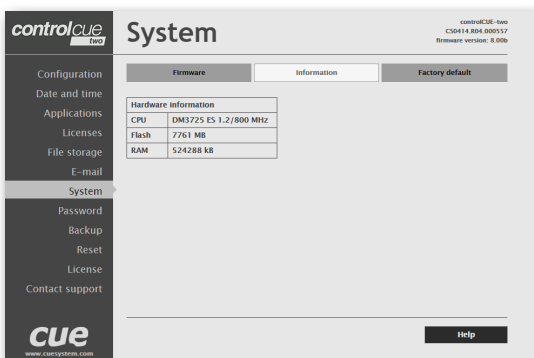

The page shows basic information about your CUEunit's hardware. The CPU type, CPU frequency, and the flash and RAM memory sizes are shown.

Factory default

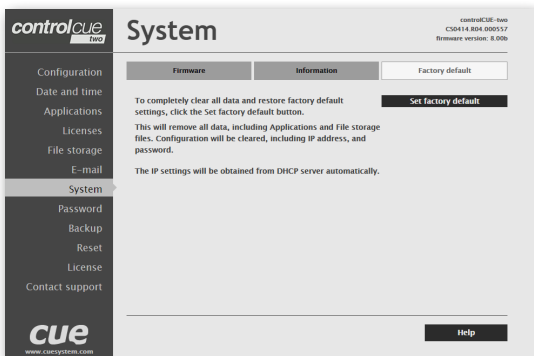

To completely clear all data and restore factory default settings, click the Set Factory Default button.

This will remove all data, including Applications and File storage files. Configuration will be cleared, including IP address and password. DHCP will be enabled and IP address will be get from DHCP server.

Password

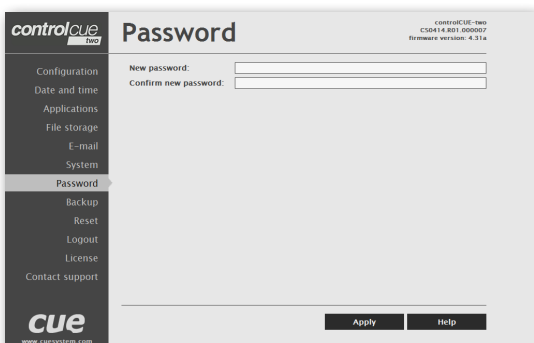

A case sensitive password is necessary to login to the admin web pages. Set a new password via the New password box. You must reenter the password in the Confirm new password box. An error message will appear if the confirmation does not match, in which case you should reenter your password again in both boxes.

Finally, the new password is implemented by clicking the Apply button.

Backup

Backup

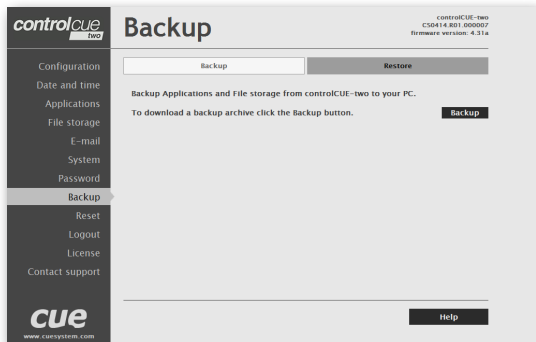

The page is used for the backup applications, files, folders and CUEunit’s configuration. The Backup copies all Applications, Application data, File storage and CUEunit’s settings to the one archive. This archive is saved to the PC. To start the backup process, click the Backup button.

Note: To see the backed-up/restored applications, click the Applications menu. To see backed-up/restored files and folders, click the File Storage menu. The page is used for the backup of all applications, files and folders.

Restore

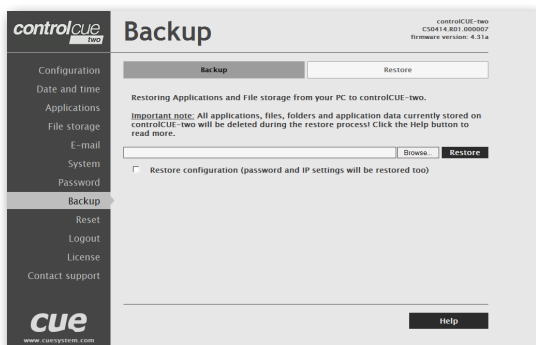

READ ALL IMPORTANT NOTES THAT FOLLOW BEFORE USING THIS OPERATION!

The page is used for the restoring of all applications, files and folders. Restore copies of all applications, files, and folders from a backup archive on the PC to their corresponding locations on the CUEunit.

To start the restore process, select the desired backup archive, then click the Restore button. The restore process can take up to 10 minutes, depending on the size of the files being restored.

If you want CUEunit’s settings will be restored too, check the “Restore configuration” box. The CUEunit’s settings are accessible via the Configuration, Date and time and Password menus.

Important note: actual password and IP settings will be restored too.

Important note: When restoring files, the running application will be stopped and all applications, files, and folders currently stored in the CUEunit will be deleted! If you want to retain them, use the Backup command before the Restore command.

Note: To see the backed-up/restored applications, click the Applications menu. To see backed-up/restored files and folders, click the File Storage menu.

Reset

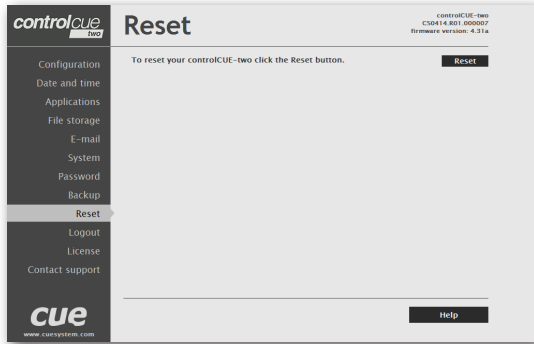

To restart your CUEunit, click the Reset button.

Logout

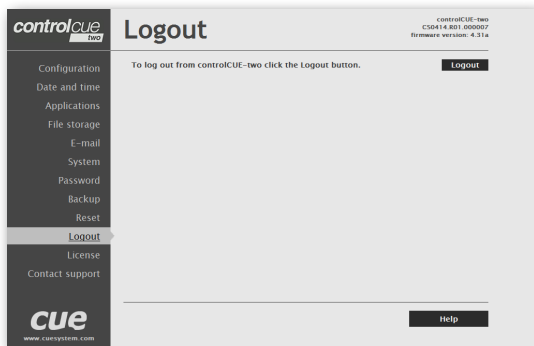

This screen isn't displayed if password is empty (factory default status).

License

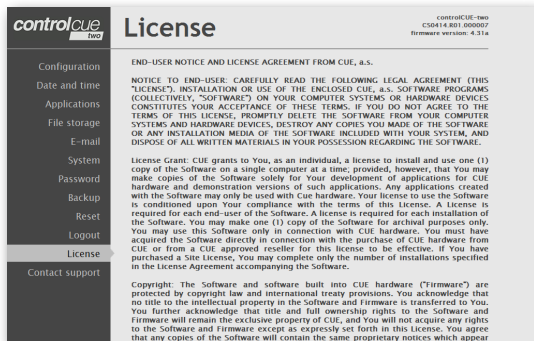

This page describes software license.

Software and Firmware License

END-USER NOTICE AND LICENSE AGREEMENT FROM CUE, a.s.

NOTICE TO END-USER: CAREFULLY READ THE FOLLOWING LEGAL AGREEMENT (THIS "LICENSE").

INSTALLATION OR USE OF THE ENCLOSED CUE, a.s. SOFTWARE PROGRAMS (COLLECTIVELY, "SOFTWARE") ON YOUR COMPUTER SYSTEMS OR HARDWARE DEVICES CONSTITUTES YOUR ACCEPTANCE OF THESE TERMS. IF YOU DO NOT AGREE TO THE TERMS OF THIS LICENSE, PROMPTLY DELETE THE SOFTWARE FROM YOUR COMPUTER SYSTEMS AND HARDWARE DEVICES, DESTROY ANY COPIES YOU MADE OF THE SOFTWARE OR ANY INSTALLATION MEDIA OF THE SOFTWARE INCLUDED WITH YOUR SYSTEM, AND DISPOSE OF ALL WRITTEN MATERIALS IN YOUR POSSESSION REGARDING THE SOFTWARE.

License Grant: CUE grants to You, as an individual, a license to install and use one (1) copy of the Software on a single computer at a time; provided, however, that You may make copies of the Software solely for Your development of applications for CUE hardware and demonstration versions of such applications. Any applications created with the Software may only be used with Cue hardware. Your license to use the Software is conditioned upon Your compliance with the terms of this License. A License is required for each end-user of the Software. A license is required for each installation of the Software. You may make one (1) copy of the Software for archival purposes only. You may use this Software only in connection with CUE hardware. You must have acquired the Software directly in connection with the purchase of CUE hardware from CUE or from a CUE approved reseller for this license to be effective. If You have purchased a Site License, You may complete only the number of installations specified in the License Agreement accompanying the Software.

Copyright: The Software and software built into CUE hardware ("Firmware") are protected by copyright law and international treaty provisions. You acknowledge that no title to the intellectual property in the Software and Firmware is transferred to You. You further acknowledge that title and full ownership rights to the Software and Firmware will remain the exclusive property of CUE, and You will not acquire any rights to the Software and Firmware except as expressly set forth in this License. You agree that any copies of the Software will contain the same proprietary notices which appear on and in the Software.

Prohibited Uses: Without obtaining prior written permission from CUE, You may not (a.) use, copy, modify, alter, or transfer the Software or documentation except as expressly provided in this License; (b.) translate, disassemble, decompile, reverse program or otherwise reverse engineer the Software and Firmware; (c.) sublicense or lease the Software or its documentation (d.) use this Software with any hardware other than products produced by CUE or in connection with applications being developed for CUE hardware; or (e.) use the Software in a multi-user, network, or multiple computer environment or in a rental, time sharing or computer service business. Without prejudice to any other rights, CUE may terminate this License if You fail to comply with its terms and conditions. In such event, You must immediately destroy all copies of the Software.

No Other Warranties: CUE DOES NOT WARRANT THAT THE SOFTWARE AND FIRMWARE IS ERROR FREE. CUE DISCLAIMS ALL WARRANTIES WITH RESPECT TO THE SOFTWARE AND FIRMWARE, EITHER EXPRESS OR IMPLIED, INCLUDING BUT NOT LIMITED TO IMPLIED WARRANTIES OF MERCHANTABILITY, FITNESS FOR A PARTICULAR PURPOSE AND NONINFRINGEMENT OF THIRD PARTY RIGHTS. SOME JURISDICTIONS DO NOT ALLOW THE EXCLUSION OF IMPLIED WARRANTIES OR LIMITATIONS OF HOW LONG AN IMPLIED WARRANTY MAY LAST, OR THE EXCLUSION OF LIMITATION OF INCIDENTAL DAMAGES, SO THE ABOVE LIMITATIONS OR EXCLUSIONS MAY NOT APPLY TO YOU. THIS WARRANTY GIVES YOU SPECIFIC LEGAL RIGHTS AND YOU MAY ALSO HAVE OTHER RIGHTS WHICH VARY FROM JURISDICTION TO JURISDICTION.

No Liability for Consequential Damages: IN NO EVENT SHALL CUE BE LIABLE TO YOU FOR ANY CONSEQUENTIAL, SPECIAL, INCIDENTAL, OR INDIRECT DAMAGES OF ANY KIND ARISING OUT OF THE PERFORMANCE OR USE OF THE SOFTWARE, EVEN IF CUE HAS BEEN ADVISED OF THE POSSIBILITY OF SUCH DAMAGES.

Label on Hardware: Use of this hardware and the software programs controlling this hardware is subject to the terms of the Software and Hardware License Agreements (the "License Agreements"). You should not use the software and hardware until you have read the License Agreements. By using the software and hardware, you signify that you have read the Licenses Agreements and accept their terms. The "License Agreement" is available at www.cuesystem.com.

Trademark Notice: CUE and the CUE logo are trademarks of CUE, a.s. in the United States and in other countries.

Notes

CUE, a.s.
K Nouzovu 6, 143 00 Praha 4, Czech Republic
www.cuesystem.com
support@cuesystem.com

cue