

Wash FX 2

User Manual

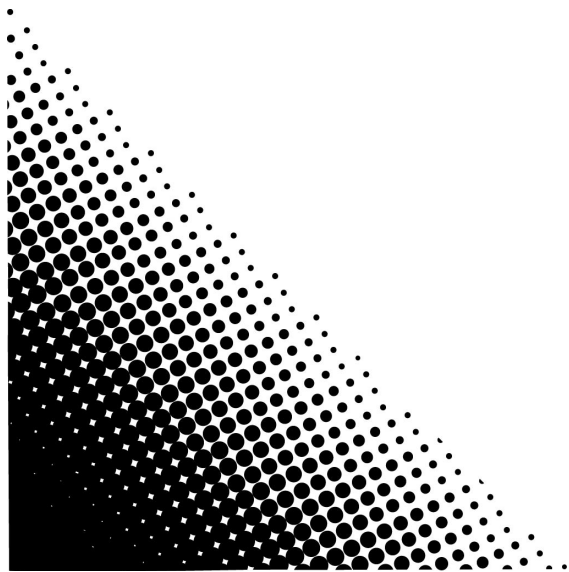
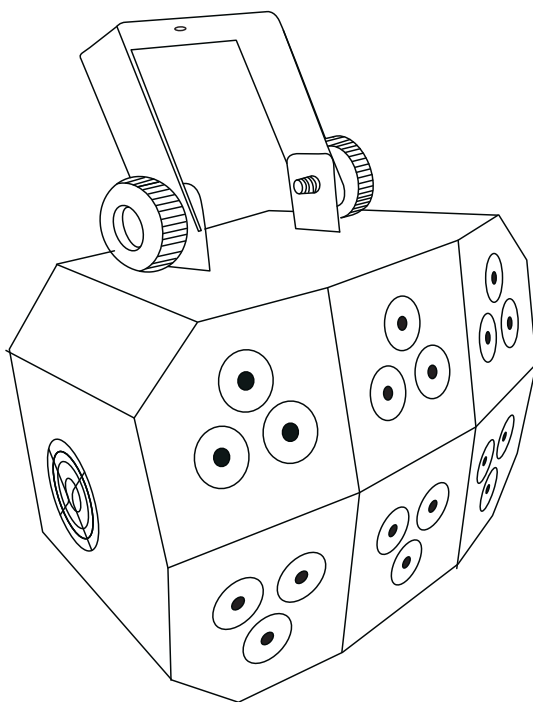

TABLE OF CONTENTS

1. Before You Begin	1
What Is Included	1
Unpacking Instructions	1
Claims	1
Text Conventions	1
Symbols	1
Disclaimer	1
Intellectual Property	1
Safety Notes	2
2. Introduction	3
Product Overview	3
Product Dimensions	4
3. Setup	5
AC Power	5
Fuse Replacement	5
Power Linking	5
Mounting	6
Orientation	6
Rigging	6
4. Operation	7
Control Panel Operation	7
Menu Map	7
Configuration (DMX)	7
DMX Personalities	7
Starting Address	7
DMX Channel Assignments and Values	8
28Ch	8
8Ch	9
4Ch	9
3Ch	10
Configuration (Standalone)	11
Automatic Programs	11
Auto-Program Speed	11
Auto-Program Dimmer	11
Sound-Active Mode	11
Sound Sensitivity	11
Preset Color Mode	11
Custom Color Mixing	11
IRC-6 Infrared Remote Control	12
IRC-6 Operation	12
Master/Slave Mode	13
5. Maintenance	14
Product Maintenance	14
6. Technical Specifications	15
Returns	16
Contact Us	17

1. BEFORE YOU BEGIN

What Is Included

- Wash FX 2
- Power cord
- Quick Reference Guide

Unpacking Instructions

Carefully unpack the product immediately and check the container to make sure all the parts are in the package and are in good condition.

Claims





If the box or the contents (the product and included accessories) appear damaged from shipping, or show signs of mishandling, notify the carrier immediately, not Chauvet. Failure to report damage to the carrier immediately may invalidate your claim. In addition, keep the box and contents for inspection.

For other issues, such as missing components or parts, damage not related to shipping, or concealed damage, file a claim with Chauvet within 7 days of delivery.

Text Conventions

CONVENTION	MEANING
1–512	A range of values
50/60	A set of values of which only one can be chosen
Settings	A menu option not to be modified
<ENTER>	A key to be pressed on the product's control panel
ON	A value to be entered or selected

Symbols

SYMBOL	MEANING
	Electrical warning. Not following these instructions may cause electrical damage to the product, accessories, or the user.
	Critical installation, configuration, or operation information. Not following these instructions may make the product not work, cause damage to the product, or cause harm to the operator.
	Important installation or configuration information. The product may not function correctly if this information is not used.
	Useful information.

Disclaimer

Chauvet believes that the information contained in this manual is accurate in all respects. However, Chauvet assumes no responsibility and specifically disclaims any and all liability to any party for any loss, damage or disruption caused by any errors or omissions in this document, whether such errors or omissions result from negligence, accident or any other cause. Chauvet reserves the right to revise the content of this document without any obligation to notify any person or company of such revision, however, Chauvet has no obligation to make, and does not commit to make, any such revisions. Download the latest version from www.chauvetdj.com.

Intellectual Property

The works of authorship contained in this manual, including, but not limited to, all design, text and images are owned by Chauvet.

© Copyright 2021 Chauvet & Sons, LLC. All rights reserved.

Electronically published by Chauvet in the United States of America.

CHAUVET, the Chauvet logo, and Wash FX 2 are registered trademarks or trademarks of Chauvet & Sons LLC (d/b/a Chauvet and Chauvet Lighting) in the United States and other countries. Other company and product names and logos referred to herein may be trademarks of their respective companies.

Safety Notes



- Always connect the product to a grounded circuit.
- Make sure the power cord is not crimped or damaged.
- Always disconnect the product from the power source before cleaning it or replacing the fuse.
- Never disconnect the product from the power source by pulling or tugging on the cord.
- If mounting the product overhead, make sure there is adequate support for the product's weight and always secure the product using a safety cable.
- Make sure there are no flammable materials close to the product when it is operating.
- Avoid direct eye exposure to the light source while the product is on.
- Do not touch the product's housing when the product is operating because the housing can be very hot.



- The product is not intended for permanent installation.
- The product is for indoor use only. It is rated at IP20.
- Do not expose the product to rain or moisture.
- Always connect the product to a power source that is within the voltage range stated on the label or rear panel of the product.
- Never connect the product to a dimmer or rheostat.
- Make sure to replace the fuse with another of the same type and rating.
- Always install the product in a location with adequate ventilation.
- Always leave at least 20 in (50 cm) between the product and adjacent surfaces.
- Be sure that no ventilation slots on the product's housing are blocked.
- Do not operate the product at an ambient temperature higher than 104 °F (40 °C).
- Never carry the product by the power cord or any moving part.
- Always use the mounting/hanging bracket to lift the product.
- If there is a serious operating problem, stop using the product immediately.
- Never try to repair the product. Repairs carried out by untrained people can lead to damage or malfunction.
- To eliminate wear and improve its lifespan, during periods of non-use completely disconnect from power via breaker or by unplugging it.



Keep this User Manual for future use. If you sell the product, be sure that they also receive this document.

2. INTRODUCTION

Product Overview

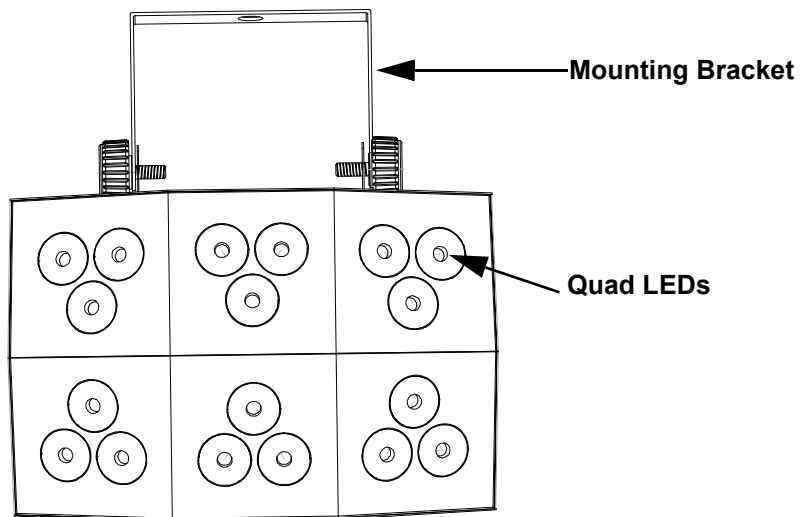
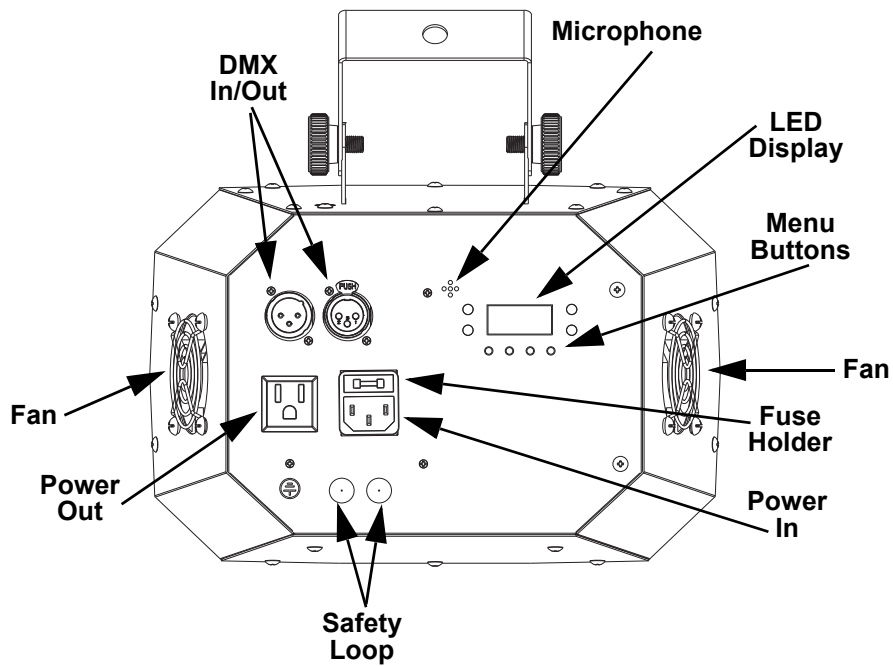

Product Dimensions

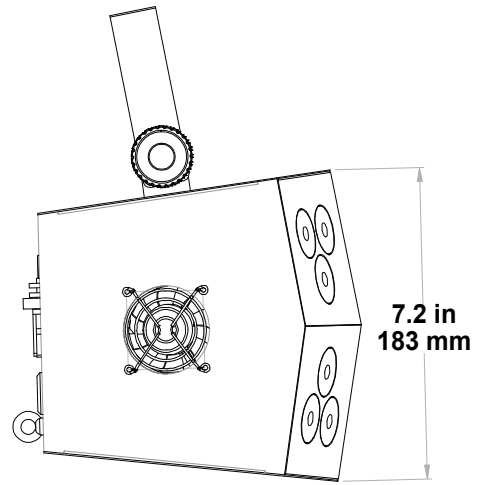
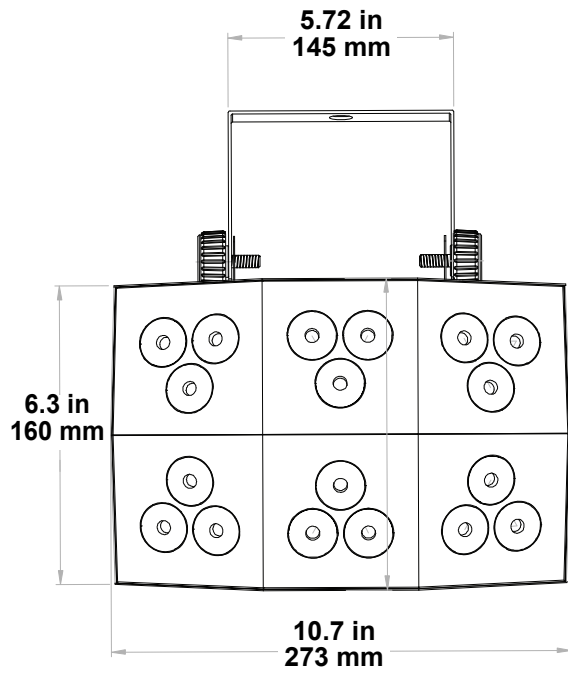

3. SETUP

AC Power

The Wash FX 2 has an auto-ranging power supply and it can work with an input voltage range of 100 to 240 VAC, 50/60 Hz. To determine the product's power requirements (circuit breaker, power outlet, and wiring), use the current value listed on the label affixed to the product's back panel, or refer to the product's specifications chart. The listed current rating indicates the product's average current draw under normal conditions.



- **Always connect the product to a protected circuit (a circuit breaker or fuse). Make sure the product has an appropriate electrical ground to avoid the risk of electrocution or fire.**
- **To eliminate unnecessary wear and improve its lifespan, during periods of non-use completely disconnect the product from power via breaker or by unplugging it.**



Never connect the product to a rheostat (variable resistor) or dimmer circuit, even if the rheostat or dimmer channel serves only as a 0 to 100% switch.

Fuse Replacement

1. Wedge the tip of a flat-head screwdriver into the slot of the fuse holder.
2. Pry the fuse holder out of the housing.
3. Remove the blown fuse from the holder and replace with a fuse of the exact same type and rating.
4. Insert the fuse holder back in place and reconnect power.

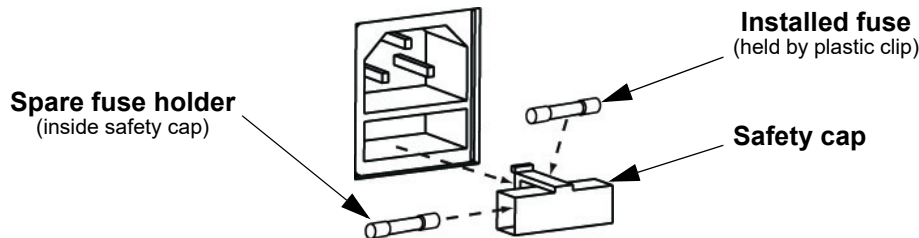

Disconnect the product from the power outlet before replacing the fuse.

Power Linking

The product provides power linking via the Edison outlet located in the back of the product. Please see the diagram below for further explanation.

Power Linking Diagram

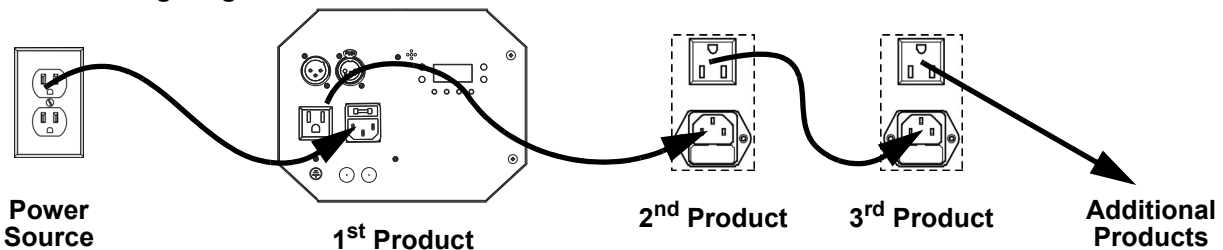

You can power link up to 6 Wash FX 2 products on 120 VAC or up to 12 Wash FX 2 products on 230 VAC.



The power linking diagram corresponds to the North American version of the product ONLY! If using the product in other markets, you must consult with the local Chauvet distributor as power linking connectors and requirements may differ in your country or region.

Mounting

Before mounting the product, read and follow the safety recommendations indicated in the [Safety Notes](#).

Orientation

The Wash FX 2 may be mounted in any position; however, make sure adequate ventilation is provided around the product.

Rigging

- Before deciding on a location, always make sure there is easy access to the product for maintenance and programming purposes.
- Make sure adequate ventilation is provided around the product.
- Make sure that the structure or surface onto which you are mounting the product can support the product's weight. (see the [Technical Specifications](#))
- When mounting the product overhead, always use a safety cable. Mount the product securely to a rigging point, whether an elevated platform or a truss.
- When rigging the product onto a truss, use a mounting clamp of appropriate weight capacity.
- When power linking multiple products, mount the products close enough for power linking cables to reach.
- The bracket adjustment knobs allow for directional adjustment when aiming the product to the desired angle. Only loosen or tighten the bracket knobs manually. Using tools could damage the knobs.

Mounting Diagram

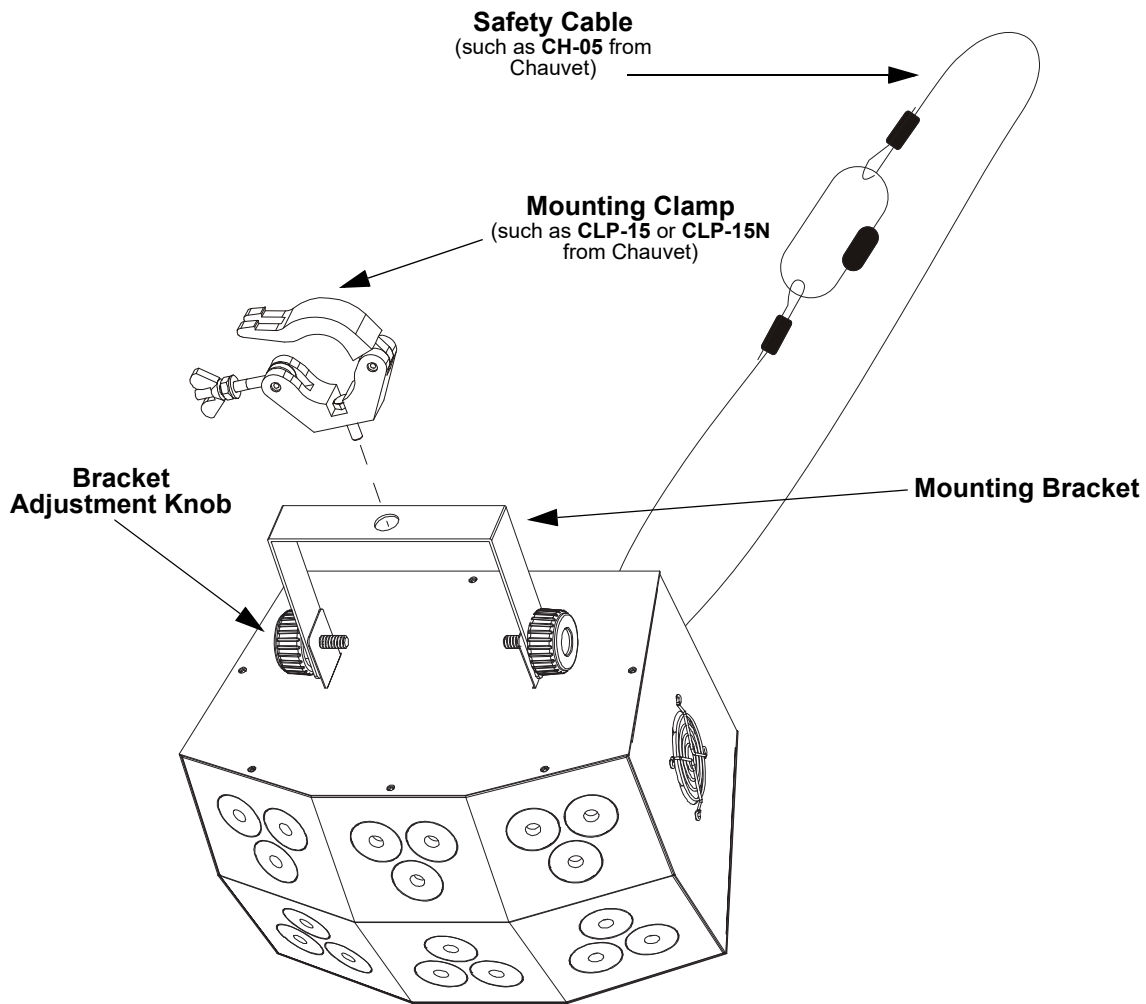

4. OPERATION

Control Panel Operation

To access the control panel functions, use the four buttons located underneath the display. Please refer to the [Product Overview](#) to see the button locations on the control panel.

Button	Function
<MENU>	Press to find an operation mode or to back out of the current menu option
<UP>	Press to scroll up the list of options or to find a higher value
<DOWN>	Press to scroll down the list of options or to find a lower value
<ENTER>	Press to activate a menu option or a selected value

Menu Map

Mode	Programming Levels		Description
DMX Mode	3Ch	d001-512	Sets the DMX personality
	4Ch		
	8Ch		
	28Ch		
Static Colors	C---	C001-022	Static colors
Auto Programs	P---	P001-025	Auto programs
Auto Speed	S---	S001-100	Program speed for P1~P16
Dimmer	dIM	L001-255	Adjust the dimmer on auto and sound programs
Sound-Active Mode	Snd	Snd1-9	Sound-active programs
Sound Sensitivity	SenS	u001-100	Sound sensitivity
Custom Color Mixing	U--	r000-255	Custom static colors Combines Red, Green, Blue, and White
		G000-255	
		b000-255	
		P000-255	
Infrared Mode	Set	on	Turns infrared on or off
		oFF	

Configuration (DMX)

The Wash FX 2 works with a DMX controller. Information about DMX is in the CHAUVET DMX Primer, which is available from the Chauvet website http://www.chauvetlighting.com/downloads/DMX_Primer_rev05_WO.pdf.

DMX Personalities

The Wash FX 2 has four DMX personalities; a 3Ch, 4Ch, 8Ch, and 28-channel personality.

To choose which DMX personality to use, follow the steps below:

1. Press <MENU> repeatedly and either 3Ch, 4Ch, 8Ch, or 28Ch will show on the display.
2. Use <UP> or <DOWN> to select the desired DMX personality.
3. Press <ENTER>.

Starting Address

When selecting a starting DMX address, always consider the number of DMX channels the selected DMX mode uses. If you choose a starting address that is too high, you could restrict the access to some of the product's channels. The Wash FX 2 uses up to 28 DMX channels, which defines the highest configurable address as **485**. Download the DMX Primer from www.chauvetdj.com.

To select the starting address, do the following:

1. Press <MENU> repeatedly until **3Ch**, **4Ch**, **8Ch**, or **28Ch** shows on the display.
2. Press <ENTER>.
3. Use <UP> or <DOWN> to select the starting address, from **d 1–512**.
4. Press <ENTER>.

DMX Channel Assignments and Values
28Ch

Channel	Function	Value	Percent/Setting
1	Auto Program	000 ⇔ 005	No function
		006 ⇔ 020	Program 1
		021 ⇔ 035	Program 2
		036 ⇔ 050	Program 3
		051 ⇔ 065	Program 4
		066 ⇔ 080	Program 5
		081 ⇔ 095	Program 6
		096 ⇔ 110	Program 7
		111 ⇔ 125	Program 8
		126 ⇔ 140	Program 9
		141 ⇔ 155	Program 10
		156 ⇔ 170	Program 11
		171 ⇔ 185	Program 12
		186 ⇔ 200	Program 13
		201 ⇔ 215	Program 14
		216 ⇔ 230	Program 15
		231 ⇔ 255	Program 16
2	Auto program Speed	000 ⇔ 250	Speed, slow to fast
		251 ⇔ 255	Sound Active Mode
3	Dimmer	000 ⇔ 255	Master dimmer
4	Strobe	000 ⇔ 255	0-20 Hz, slow to fast
5	Red Zone 1	000 ⇔ 255	0-100%
6	Green Zone 1	000 ⇔ 255	0-100%
7	Blue Zone 1	000 ⇔ 255	0-100%
8	UV Zone 1	000 ⇔ 255	0-100%
9	Red Zone 2	000 ⇔ 255	0-100%
10	Green Zone 2	000 ⇔ 255	0-100%
11	Blue Zone 2	000 ⇔ 255	0-100%
12	UV Zone 2	000 ⇔ 255	0-100%
13	Red Zone 3	000 ⇔ 255	0-100%
14	Green Zone 3	000 ⇔ 255	0-100%
15	Blue Zone 3	000 ⇔ 255	0-100%
16	UV Zone 3	000 ⇔ 255	0-100%
17	Red Zone 4	000 ⇔ 255	0-100%
18	Green Zone 4	000 ⇔ 255	0-100%
19	Blue Zone 4	000 ⇔ 255	0-100%
20	UV Zone 4	000 ⇔ 255	0-100%
21	Red Zone 5	000 ⇔ 255	0-100%
22	Green Zone 5	000 ⇔ 255	0-100%
23	Blue Zone 5	000 ⇔ 255	0-100%
24	UV Zone 5	000 ⇔ 255	0-100%
25	Red Zone 6	000 ⇔ 255	0-100%
26	Green Zone 6	000 ⇔ 255	0-100%
27	Blue Zone 6	000 ⇔ 255	0-100%
28	UV Zone 6	000 ⇔ 255	0-100%

8Ch

Channel	Function	Value	Percent/Setting
1	Red	000 ⇔ 255	0–100%
2	Green	000 ⇔ 255	0–100%
3	Blue	000 ⇔ 255	0–100%
4	UV	000 ⇔ 255	0–100%
5	Strobe	000 ⇔ 255	0-20 Hz, slow to fast
6	Auto Program	000 ⇔ 005	No function
		006 ⇔ 020	Program 1
		021 ⇔ 035	Program 2
		036 ⇔ 050	Program 3
		051 ⇔ 065	Program 4
		066 ⇔ 080	Program 5
		081 ⇔ 095	Program 6
		096 ⇔ 110	Program 7
		111 ⇔ 125	Program 8
		126 ⇔ 140	Program 9
		141 ⇔ 155	Program 10
		156 ⇔ 170	Program 11
		171 ⇔ 185	Program 12
		186 ⇔ 200	Program 13
		201 ⇔ 215	Program 14
		216 ⇔ 230	Program 15
231 ⇔ 255	Program 16		
7	Auto Program Speed	000 ⇔ 250	Speed, slow to fast
		251 ⇔ 255	Sound Active Mode
8	Dimmer	000 ⇔ 255	Auto and Sound Programs

4Ch

Channel	Function	Value	Percent/Setting
1	Red	000 ⇔ 255	0–100%
2	Green	000 ⇔ 255	0–100%
3	Blue	000 ⇔ 255	0–100%
4	UV	000 ⇔ 255	0–100%

3Ch

Channel	Function	Value	Percent/Setting
1	Auto Program	000 ⇔ 005	No function
		006 ⇔ 020	Program 1
		021 ⇔ 035	Program 2
		036 ⇔ 050	Program 3
		051 ⇔ 065	Program 4
		066 ⇔ 080	Program 5
		081 ⇔ 095	Program 6
		096 ⇔ 110	Program 7
		111 ⇔ 125	Program 8
		126 ⇔ 140	Program 9
		141 ⇔ 155	Program 10
		156 ⇔ 170	Program 11
		171 ⇔ 185	Program 12
		186 ⇔ 200	Program 13
		201 ⇔ 215	Program 14
		216 ⇔ 230	Program 15
231 ⇔ 255	Program 16		
2	Auto Program Speed	000 ⇔ 250	Speed, slow to fast
		251 ⇔ 255	Sound Active Mode
3	Dimmer	000 ⇔ 255	Auto and Sound Programs

Configuration (Standalone)

Set the product in one of the standalone modes to control without a DMX controller.



Never connect a product that is operating in any standalone mode to a DMX string connected to a DMX controller. Products in standalone mode may transmit DMX signals that could interfere with the DMX signals from the controller.

Automatic Programs

To run the Wash FX 2 in automatic mode, follow the instructions below:

1. Press **<MENU>** repeatedly until **P---** shows on the display.
2. Press **<ENTER>**.
3. Use **<UP>** or **<DOWN>** to select an automatic program, from **P001–025**.
4. Press **<ENTER>**.

Auto-Program Speed

To change the auto-program speed on the Wash FX 2, do the following:

1. Press **<MENU>** repeatedly until **S---** shows on the display.
2. Use **<UP>** or **<DOWN>** to increase or decrease the program speed, from **S001–100**.
3. Press **<ENTER>**. The product will return to the last selected mode.

Auto-Program Dimmer

To control the output intensity of the Quad-LEDs while running an auto-program, follow the instructions below:

1. Press **<MENU>** repeatedly until **dim** shows on the display.
2. Press **<ENTER>**.
3. Use **<UP>** or **<DOWN>** to increase or decrease the Quad-LED intensity, from **L000–255**.

Sound-Active Mode

To run the Wash FX 2 in sound-active mode, do the following:

1. Press **<MENU>** repeatedly until **Snd** shows on the display.
2. Press **<ENTER>**.
3. Use **<UP>** or **<DOWN>** to select a sound-active program, from **Snd1–9**.
4. Press **<ENTER>**.
5. Turn the sensitivity knob up until the product responds to the beat of the music.



The product will only respond to low frequencies of music (bass and drums).

Sound Sensitivity

To set the sound sensitivity on the Wash FX 2, do the following:

1. Press **<MENU>** repeatedly until **SenS** shows on the display.
2. Use **<UP>** or **<DOWN>** to increase or decrease the sound sensitivity, from **u001–100**.
3. Press **<ENTER>**.

Preset Color Mode

To run the Wash FX 2 on a static color, follow the instructions below:

1. Press **<MENU>** repeatedly until **C---** shows on the display.
2. Press **<ENTER>**.
3. Use **<UP>** or **<DOWN>** to select a static color, from **C001–022**.
4. Press **<ENTER>**.

Custom Color Mixing

To custom mix a static color, do the following:

1. Press **<MENU>** repeatedly until **U---** shows on the display.
2. Press **<ENTER>** and one of the following will show on the display:

• r_ _ _ (red)	• b_ _ _ (blue)
• G_ _ _ (green)	• P_ _ _ (UV)
3. Press **<ENTER>** to cycle through the settings.
4. When the desired setting shows on the display, use **<UP>** or **<DOWN>** to increase or decrease the value, from **0–255** for red, green, blue, or UV.
5. Repeat steps 3 and 4 until the product outputs as desired.



Of the four colors (red, green, blue, and UV), only three may be used at one time.

IRC-6 Infrared Remote Control

The Wash FX 2 is compatible with the IRC-6 infrared remote control from Chauvet. To activate IR mode, follow the instructions below:

1. Press **<MENU>** repeatedly until **Set** shows on the display.
2. Press **<ENTER>** to accept.
3. Press **<UP>** or **<DOWN>** to select **on** or **OFF**.
4. Press **<ENTER>**.

IRC-6 Operation

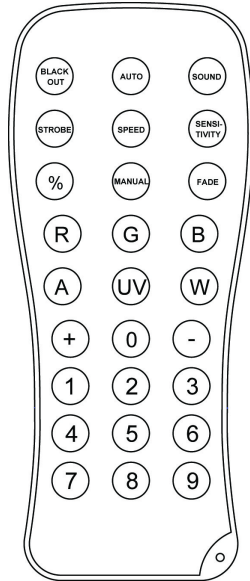

Automatic Mode

Automatic mode will enable you to run the automatic programs on the product.

To turn on Automatic mode:

- Press **<AUTO>** on the IRC-6.

To adjust the speed of the automatic program:

1. Press **<SPEED>** on the IRC-6.
2. Press **<+>** or **<->** to increase or decrease the speed of the program.

Sound-Active Mode

Sound-Active mode will enable the product to respond to the music.

To turn on Sound-Active mode:

- Press **<SOUND>** on the IRC-6.

Manual Color Control

- To choose a specific color with the IRC-6: Press any number between **<0>**–**<9>** to choose your color.

To manually control the RGB percentage:

1. Press **<MANUAL>** on the IRC-6.
2. Press **<R>** (red), **<G>** (green), **** (blue), or **<UV>**/**<P>** (UV) to choose your color.
3. Press **<+>** or **<->** to increase or decrease the percentage of each color.

NOTE: Only three colors can be used at once.

To set all LEDs to full intensity:

- Press **<0>** on the IRC-6.

Miscellaneous Operation

To adjust the output level of the Quad LEDs in manual color mode:

- Press **<%>** repeatedly on the IRC-6.

To adjust the strobe rate of the static color:

1. Press **<STROBE>** on the IRC-6.
2. Press **<+>** or **<->** to increase or decrease the strobe rate.
3. Press **<STROBE>** again to turn off the Strobe effect.

To select a fading program:

- Press **<FADE>** on the IRC-6. Press it repeatedly to cycle through fading programs.

To black out the lights:

- Press **<BLACK OUT>** on the IRC-6.

This will turn off all the lights until the button is pressed again.

NOTE: The IRC-6 will not respond to any inputs when Black Out is activated. If the remote does not respond when a button is pressed, try pressing **<BLACK OUT>**. You may have inadvertently activated Black Out.

Master/Slave Mode

The Master/Slave mode allows a single Wash FX 2 product (the “master”) to control the actions of one or more Wash FX 2 products (the “slaves”) without the need of a DMX controller. The master product will be set to operate in either Stand-Alone mode or with the IRC-6, while the slave products will be set to operate in Slave mode. Once set and connected, the slave products will operate in unison with the master product. Configure the products as indicated below.

Slave products:

1. Press **<MENU>** repeatedly until **3Ch, 4Ch, 8Ch, or 28Ch** shows on the display.
2. Press **<ENTER>** to accept.
3. Set the DMX address to **d001**.
4. Connect the DMX input of the first slave product to the DMX output of the master product.
5. Connect the DMX input of the subsequent slave products to the DMX output of the previous slave product.
6. Finish setting and connecting all the slave products.

Master product:

1. Set the master product to operate in Stand-Alone mode or with the IRC-6.
2. Make the master product the first product in the DMX daisy chain.
 - **Configure all the slave products before connecting the master to the daisy chain.**
 - **Never connect a DMX controller to a DMX string configured for Master/Slave operation because the controller may interfere with the signals from the master.**
 - **Do not connect more than 31 slaves to the master.**



5. MAINTENANCE

Product Maintenance

Dust build-up reduces light output performance and can cause overheating. This can lead to reduction of the light source's life and/or mechanical wear. To maintain optimum performance and minimize wear, clean your lighting products at least twice a month. However, be aware that usage and environmental conditions could be contributing factors to increase the cleaning frequency.

To clean the product, follow the instructions below:

1. Unplug the product from power.
2. Wait until the product is at room temperature.
3. Use a vacuum (or dry compressed air) and a soft brush to remove dust collected on the external surface/vents.
4. Clean all transparent surfaces with a mild soap solution, ammonia-free glass cleaner, or isopropyl alcohol.
5. Apply the solution directly to a soft, lint free cotton cloth or a lens cleaning tissue.
6. Softly drag any dirt or grime to the outside of the transparent surface.
7. Gently polish the transparent surfaces until they are free of haze and lint.



Always dry the transparent surfaces carefully after cleaning them.



Do not spin the cooling fans using compressed air because it may damage them.

6. TECHNICAL SPECIFICATIONS

Dimensions and Weight

Length	Width	Height	Weight
10.7 in (273 mm)	6.3 in (160 mm)	7.2 in (183 mm)	5.8 lb (2.6 kg)

Note: Dimensions in inches rounded to the nearest decimal digit.

Power

Power Supply Type	Range	Voltage Selection
Switching (internal)	100 to 240 VAC, 50/60 Hz	Auto-ranging

Parameter	120 V, 60 Hz	230 V, 50 Hz
Consumption	145 W	141 W
Operating Current	1.3A	0.6 A
Power linking current (products)	2 A (6 products)	2 A (12 products)
Fuse	T 1 A, 250 V	T 1 A, 250 V

Power I/O	U.S./Worldwide	UK/Europe
Power input connector	IEC	IEC
Power output connector	Edison	IEC
Power Cord plug	Edison (U.S.)	Local Plug

Light Source

Type	Color	Quantity	Power	Current	Lifespan
LED	Quad-color RGB+UV	18	6 W	2 A	50,000 hours

Photometrics

Strobe Rate	Illuminance @ 2 m	PWM Frequency
0 to 25 Hz	1,795 lux (per pod)	78.126 Hz

Thermal

Maximum External Temperature	Cooling System
104 °F (40 °C)	Fan-assisted convection

DMX

I/O Connector	Channel Range
3-pin XLR	3, 4, 8 or 28

Ordering

Product Name	Item Code	UPC Number
WASHFX2	07051437	781462217853

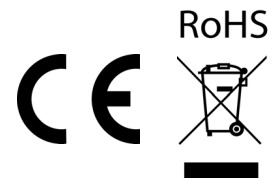

RETURNS

To get support or return a product:

- If you are located in the U.S., contact Chauvet World Headquarters.
- If you are located in the U.K. or Ireland, contact Chauvet Europe Ltd.
- If you are located in Benelux, contact Chauvet Europe BVBA.
- If you are located in France, contact Chauvet France.
- If you are located in Germany, contact Chauvet Germany.
- If you are located in Mexico, contact Chauvet Mexico.
- If you are located in any other country, DO NOT contact Chauvet. Instead, contact your local distributor. See www.chauvetdj.com for distributors outside the U.S., U.K., Ireland, Benelux, France, Germany, or Mexico



If you are located outside the U.S., U.K., Ireland, Germany, France, Benelux, or Mexico, contact your distributor of record and follow their instructions on how to return Chauvet products to them. Visit our website www.chauvetdj.com for contact details.

Call the corresponding Chauvet Technical Support office and request a Return Merchandise Authorization (RMA) number before shipping the product. Be prepared to provide the model number, serial number, and a brief description of the cause for the return.

To submit a service request online, go to www.chauvetdj.com/service-request.

Send the merchandise prepaid, in its original box, and with its original packing and accessories. Chauvet will not issue call tags.

Clearly label the package with the RMA number. Chauvet will refuse any product returned without an RMA number.



Write the RMA number on a properly affixed label. DO NOT write the RMA number directly on the box.

Before sending the product, clearly write the following information on a piece of paper and place it inside the box:

- Your name
- Your address
- Your phone number
- RMA number
- A brief description of the problem

Be sure to pack the product properly. Any shipping damage resulting from inadequate packaging will be your responsibility. FedEx packing or double-boxing are recommended.



Chauvet reserves the right to use its own discretion to repair or replace returned product(s).

CONTACT US

General Information	Technical Support
Chauvet World Headquarters	
Address: 5200 NW 108th Ave. Sunrise, FL 33351 Voice: (954) 577-4455 Fax: (954) 929-5560 Toll Free: (800) 762-1084	Voice: (844) 393-7575 Fax: (954) 756-8015 Email: chauvetcs@chauvetlighting.com Website: www.chauvetdj.com
Chauvet Europe Ltd.	
Address: Unit 1C Brookhill Road Industrial Estate Pinxton, Nottingham, UK NG16 6NT Voice: +44 (0) 1773 511115 Fax: +44 (0) 1773 511110	Email: UKtech@chauvetlighting.eu Website: www.chauvetdj.eu
Chauvet Europe BVBA	
Address: Stokstraat 18 9770 Kruishoutem Belgium Voice: +32 9 388 93 97	Email: BNLtech@chauvetlighting.eu Website: www.chauvetdj.eu
Chauvet France	
Address: 3, Rue Ampère 91380 Chilly-Mazarin France Voice: +33 1 78 85 33 59	Email: FRtech@chauvetlighting.fr Website: www.chauvetdj.eu
Chauvet Germany	
Address: Bruno-Bürgel-Str. 11 28759 Bremen Germany Voice: +49 421 62 60 20	Email: DEtech@chauvetlighting.de Website: www.chauvetdj.eu
Chauvet Mexico	
Address: Av. de las Partidas 34 - 3B (Entrance by Calle 2) Zona Industrial Lerma Lerma, Edo. de México, CP 52000 Voice: +52 (728) 690-2010	Email: servicio@chauvet.com.mx Website: www.chauvetdj.mx

Visit the applicable website above to verify our contact information and instructions to request support. Outside the U.S., U.K., Ireland, France, Germany, Benelux, or Mexico, contact the dealer of record.