



Wired Touch Panels

User Manual

CONTENTS

2	CONTENTS	
3	INTRODUCTION	
3	Overview	
3	Models and Accessories	
3	Main Features	
3	Programming	
4	BOX CONTENTS	
4	Tabletop Models	
4	Built-In Models	
5	On-Wall Multisurface Models	
6	SPECIFICATIONS	
6	Tabletop Models	
6	Built-In Models	
7	On-Wall Multisurface Models	
8	PHYSICAL DESCRIPTION	
8	Tabletop Models	
9	Built-In Models	
11	On-Wall Multisurface Models	
13	Part Description	
14	MOUNTING	
14	Tabletop Models	
14	Built-In Models	
15	On-Wall Multisurface Models	
16	CLEANING THE TOUCH PANEL	
17	CONNECTION	
17	Ethernet	
18	Direct PC Connection	
19	WINDOWS LOCAL NETWORK SETTINGS	
20	USER APPLICATION DOWNLOAD	
20	Overview	
20	Using Cue Visual Composer	
21	Using Admin Web	
22	FACTORY DEFAULT AND SYSTEM DEFAULT	
23	ON SCREEN DISPLAY	
23	Access On Screen Display	
23	Settings	
23	Status	
23	This page shows current status of the touch panel.	
23	IP Settings	
24	Date/Time	
24	Applications	
24	Exit	
25	ADMIN WEB	
25	Access Admin Web	
25	Login	
25	Configuration	
27	Date and Time	
28	Applications	
28	File Storage	
29	E-mail	
29	Settings	
30	System	
31	Password	
31	Backup	
32	Reset	
32	License	
33	SOFTWARE AND FIRMWARE LICENSE	

INTRODUCTION

Overview

The wired touch panel product line offers 4.3", 7", 10" and 12" screen sizes. For each screen size tabletop and built-in models are available. All models combine functionality such as multimedia integration, lighting automation, security monitoring, entertainment integration, and meeting & presentation control. The active matrix touch screen display offers resolution 800 x 480 pixels for 4.3" and 1280 x 800 pixels for 7", 10" and 12" screen size. All models produce stunning true colour images. Wired Ethernet connection provides easy network integration. All touch panels are equipped with Power over Ethernet (PoE for 4.3", 7", 10" and PoE+ for 12") - technology enabling an Ethernet network cable to deliver both data and power. Fully compatible with CUE controllers, these touch panels provide the ultimate one-touch solution for meeting rooms, conference rooms, boardrooms and high-tech homes.

Models and Accessories

Model	Product Code	Description	Note
touchCUE-5	CS0371	Wired tabletop touch panel 4.3"	
touchCUE-7	CS0451	Wired tabletop touch panel 7"	
touchCUE-10	CS0559	Wired tabletop touch panel 10"	
touchCUE-12	CS0466	Wired tabletop touch panel 12"	
touchCUE-5-B	CS0372	Wired built-in touch panel 4.3"	
touchCUE-7-B	CS0452	Wired built-in touch panel 7"	
touchCUE-10-B	CS0560	Wired built-in touch panel 10"	
touchCUE-12-B	CS0467	Wired built-in touch panel 12"	
touchCUE-7-M	CS0539	Wired on-wall multisurface touch panel 7"	
touchCUE-10-M	CS0561	Wired on-wall multisurface touch panel 10"	
touchCUE-12-M	CS0540	Wired on-wall multisurface touch panel 12"	

Main Features

- Wired tabletop and built-in touch panels
- 4.3", 7", 10" and 12" active matrix touch screen displays
- Resolution 800 x 480 pixels for 4.3", 1280 x 800 pixels for 7", 10" and 12"
- Colors 32-bit (True Color), transparency 8-bit Alpha blending
- Wired Ethernet communication
- Power over Ethernet power supply
- Built-in microphone and speakers
- Built-in light and proximity sensors
- Programmable RGB LED indicators located on left and right side (10" models only)
- Real time clock (RTC) for scheduling applications
- Aluminium enclosure, aluminium front panel for built-in models
- Bi-directional control of any IP enabled products through Ethernet port
- Web server and Admin Web for setup through a standard web browser

Programming

All touch panels have to be programmed using Cue Visual Composer. These models are not compatible with Cue System Director.

BOX CONTENTS

Tabletop Models



	touchCUE-5	touchCUE-7	touchCUE-10	touchCUE-12
Touch panel touchCUE-5	1			
Touch panel touchCUE-7		1		
Touch panel touchCUE-10			1	
Touch panel touchCUE-12				1
PoE Adapter	1	1	1	
PoE+ Adapter				1
Power cable	1	1	1	1
Flat Ethernet cable	1	1	1	1
Cleaning tissue	1	1	1	1
Quick Start	1	1	1	1
Declaration of Conformity	1	1	1	1
Warranty Conditions	1	1	1	1

Built-In Models



	touchCUE-5-B	touchCUE-7-B	touchCUE-10-B	touchCUE-12-B
Touch panel touchCUE-5-B	1			
Touch panel touchCUE-7-B		1		
Touch panel touchCUE-10-B			1	
Touch panel touchCUE-12-B				1
Wall Mount Adapter incl. screws	1	1	1	1
PoE Adapter	1	1	1	
PoE+ Adapter				1
Power cable	1	1	1	1
Ethernet cable	1	1	1	1
Cleaning tissue	1	1	1	1
Quick Start	1	1	1	1
Declaration of Conformity	1	1	1	1
Warranty Conditions	1	1	1	1

On-Wall Multisurface Models



	touchCUE-7-M	touchCUE-10-M	touchCUE-12-M
Touch panel touchCUE-7-M	1		
Touch panel touchCUE-10-M		1	
Touch panel touchCUE-12-M			1
Back cover incl. fixing screws	1	1	1
PoE Adapter	1	1	
PoE+ Adapter			1
Power cable	1	1	1
Ethernet cable	1	1	1
Squeegee	1	1	1
Adhesive cover foil	1	1	1
Adhesive tapes	1	1	1
Set of cable bushings	1	1	1
Cleaning tissue	1	1	1
Quick Start	1	1	1
Declaration of Conformity	1	1	1
Warranty Conditions	1	1	1

SPECIFICATIONS

Tabletop Models



	touchCUE-5	touchCUE-7	touchCUE-10	touchCUE-12
Product code	CS0371	CS0451	CS0559	CS0466
Display type	Color IPS LCD with LED backlit	Color a-Si TFT LCD with LED backlit	Color IPS LCD with LED backlit	Color a-Si TFT LCD with LED backlit
Display size	4.3" (109 mm) diagonal	7" (177.8 mm) diagonal	10.1" (256.5 mm) diagonal	12.1" (307.3 mm) diagonal
Resolution	800 x 480 pixels	1280 x 800 pixels	1280 x 800 pixels	1280 x 800 pixels
Viewing angle	160° horizontal, 170° vertical	160° horizontal, 170° vertical	170° horizontal, 170° vertical	160° horizontal, 170° vertical
Touch overlay	Projected capacitive	Projected capacitive	Projected capacitive	Projected capacitive
Side indicators	-	-	Programmable RGB LED	-
Sensors	Light and proximity	Light and proximity	Light and proximity	Light and proximity
Audio	Microphone and speakers	Microphone and speakers	Microphone and speakers	Microphone and speakers
Memory	RAM 512 MB, microSD Card min. 8 GB	RAM 512 MB, microSD Card min. 8 GB	RAM 512 MB, microSD Card min. 8 GB	RAM 512 MB, microSD Card min. 8 GB
Network	Wired 10/100 BaseT Ethernet	Wired 10/100 BaseT Ethernet	Wired 10/100 BaseT Ethernet	Wired 10/100 BaseT Ethernet
Power supply	PoE, IEEE 802.3af / Class 0	PoE, IEEE 802.3af / Class 0	PoE, IEEE 802.3af / Class 0	PoE+, IEEE 802.3at / Class 4
Enclosure	Aluminium, glass, integrated tabletop stand, Protection IP30	Aluminium, glass, integrated tabletop stand Protection IP30	Aluminium, glass, integrated tabletop stand Protection IP30	Aluminium, glass, integrated tabletop stand Protection IP30
Dimensions	136 x 81 x 73 mm	199 x 115 x 97 mm	268 x 155 x 121 mm	320 x 192 x 153 mm
Weight	0.4 kg	0.8 kg	1.1 kg	2.4 kg
Included accessories	PoE power supply, Ethernet cable	PoE power supply, Ethernet cable	PoE power supply, Ethernet cable	PoE+ power supply, Ethernet cable

Built-In Models



	touchCUE-5-B	touchCUE-7-B	touchCUE-10-B	touchCUE-12-B
Product code	CS0372	CS0452	CS0560	CS0467
Display type	Color IPS LCD with LED backlit	Color a-Si TFT LCD with LED backlit	Color IPS LCD with LED backlit	Color a-Si TFT LCD with LED backlit
Display size	4.3" (109 mm) diagonal	7" (177.8 mm) diagonal	10.1" (256.5 mm) diagonal	12.1" (307.3 mm) diagonal
Resolution	800 x 480 pixels	1280 x 800 pixels	1280 x 800 pixels	1280 x 800 pixels
Viewing angle	160° horizontal, 170° vertical	160° horizontal, 170° vertical	170° horizontal, 170° vertical	160° horizontal, 170° vertical
Touch overlay	Projected capacitive	Projected capacitive	Projected capacitive	Projected capacitive
Sensors	Light and proximity	Light and proximity	Light and proximity	Light and proximity
Side indicators	-	-	Programmable RGB LED	-
Audio	Microphone and speakers	Microphone and speakers	Microphone and speakers	Microphone and speakers
Memory	RAM 512 MB, microSD Card min. 8 GB	RAM 512 MB, microSD Card min. 8 GB	RAM 512 MB, microSD Card min. 8 GB	RAM 512 MB, microSD Card min. 8 GB
Network	Wired 10/100 BaseT Ethernet	Wired 10/100 BaseT Ethernet	Wired 10/100 BaseT Ethernet	Wired 10/100 BaseT Ethernet
Power supply	PoE, IEEE 802.3af / Class 0	PoE, IEEE 802.3af / Class 0	PoE, IEEE 802.3af / Class 0	PoE+, IEEE 802.3at / Class 4
Enclosure	Aluminium, glass, compatible with standard electrical wall box Protection IP30	Aluminium, glass, compatible with standard electrical wall box Protection IP30	Aluminium, glass, compatible with standard electrical wall box Protection IP30	Aluminium, glass, compatible with standard electrical wall box Protection IP30
Dimensions	136 x 81 x 11 mm when installed Full depth 37 mm	199 x 120 x 16 mm when installed Full depth 39 mm	268 x 167 x 16 mm when installed Full depth 37 mm	320 x 200 x 22 mm when installed Full depth 47 mm
Weight	0.3 kg	0.6 kg	0.9 kg	2.0 kg
Included accessories	PoE power supply, Ethernet cable, Wall mounting adapter	PoE power supply, Ethernet cable, Wall mounting adapter	PoE power supply, Ethernet cable, Wall mounting adapter	PoE+ power supply, Ethernet cable, Wall mounting adapter

On-Wall Multisurface Models



	touchCUE-7-M	touchCUE-10-M	touchCUE-12-M
Product code	CS0539	CS0561	CS0540
Display type	Color a-Si TFT LCD with LED backlit	Color IPS LCD with LED backlit	Color a-Si TFT LCD with LED backlit
Display size	7" (177.8 mm) diagonal	10.1" (256.5 mm) diagonal	12.1" (307.3 mm) diagonal
Resolution	1280 x 800 pixels	1280 x 800 pixels	1280 x 800 pixels
Viewing angle	160° horizontal, 170° vertical	170° horizontal, 170° vertical	160° horizontal, 170° vertical
Touch overlay	Projected capacitive	Projected capacitive	Projected capacitive
Sensors	Light and proximity	Light and proximity	Light and proximity
Side indicators	-	Programmable RGB LED	-
Audio	Microphone and speakers	Microphone and speakers	Microphone and speakers
Memory	RAM 512 MB, microSD Card min. 8 GB	RAM 512 MB, microSD Card min. 8 GB	RAM 512 MB, microSD Card min. 8 GB
Network	Wired 10/100 BaseT Ethernet	Wired 10/100 BaseT Ethernet	Wired 10/100 BaseT Ethernet
Power supply	PoE, IEEE 802.3af / Class 0	PoE, IEEE 802.3af / Class 0	PoE+, IEEE 802.3at / Class 4
Enclosure	Aluminium, edge-to edge front glass Compatible with VESA 75 x 75 mm Protection IP30	Aluminium, edge-to edge front glass Compatible with VESA 75 x 75 mm Protection IP30	Aluminium, edge-to edge front glass Compatible with VESA 75 mm x 75 mm Protection IP30
Dimensions	199 x 120 x 23 mm	268 x 167 x 25 mm	320 x 200 x 32 mm
Weight	0.8 kg	1.1 kg	2.2 kg
Included accessories	PoE power supply, Ethernet cable	PoE power supply, Ethernet cable	PoE+ power supply, Ethernet cable
Available extension	NFC Module CS0579	NFC Module CS0579	-

PHYSICAL DESCRIPTION

Tabletop Models

touchCUE-5

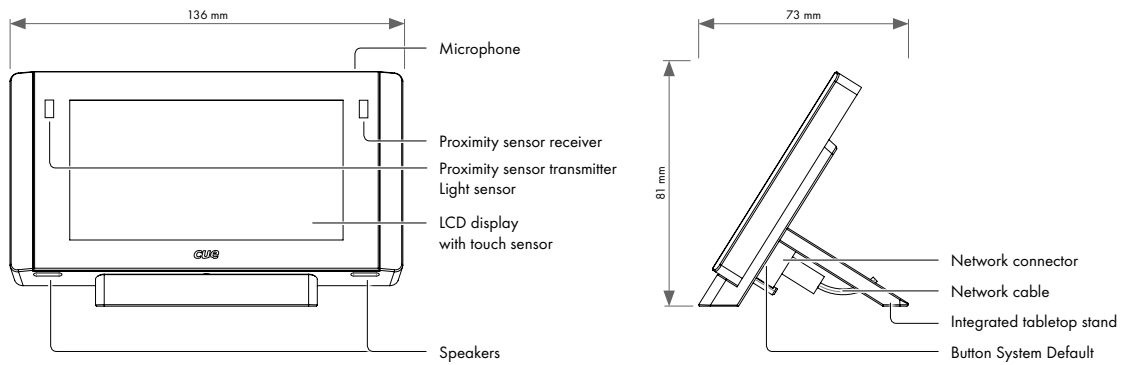

touchCUE-7

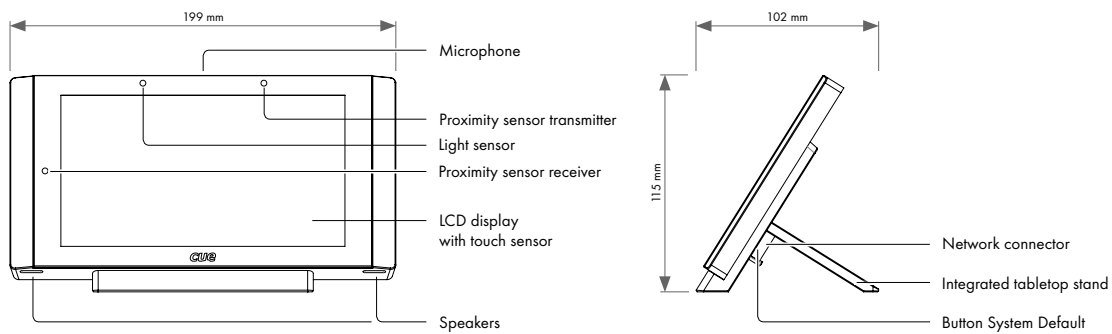

touchCUE-10

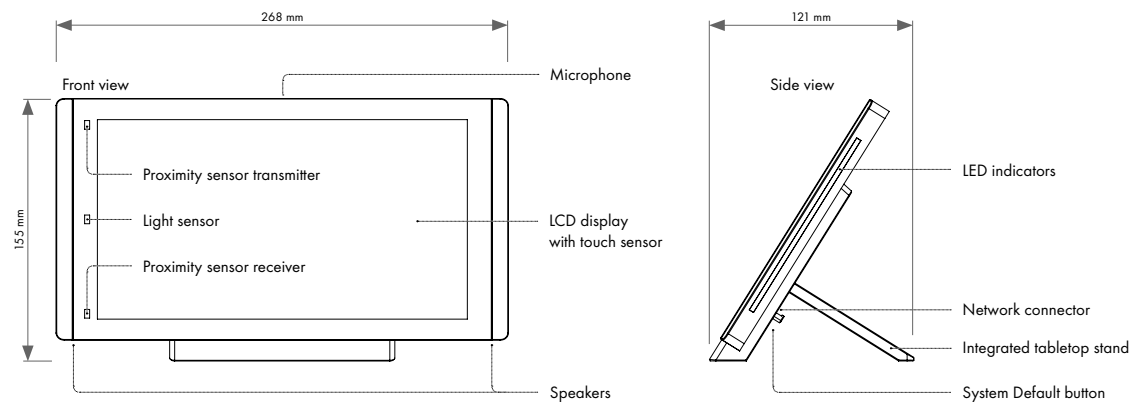

touchCUE-12

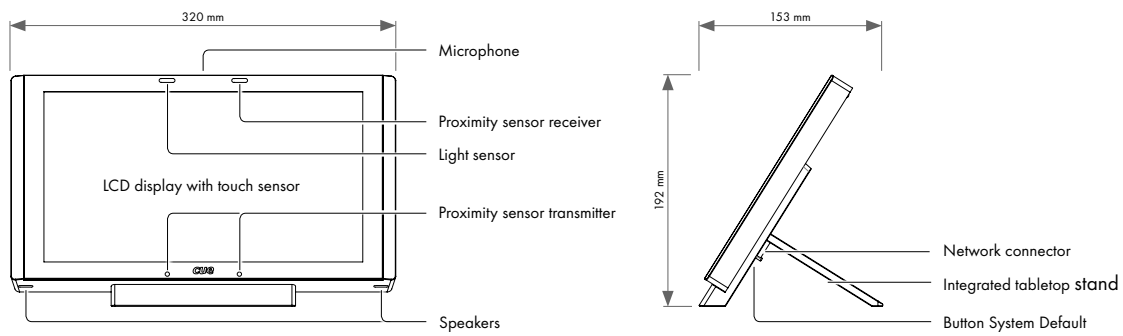

Built-In Models

touchCUE-5-B

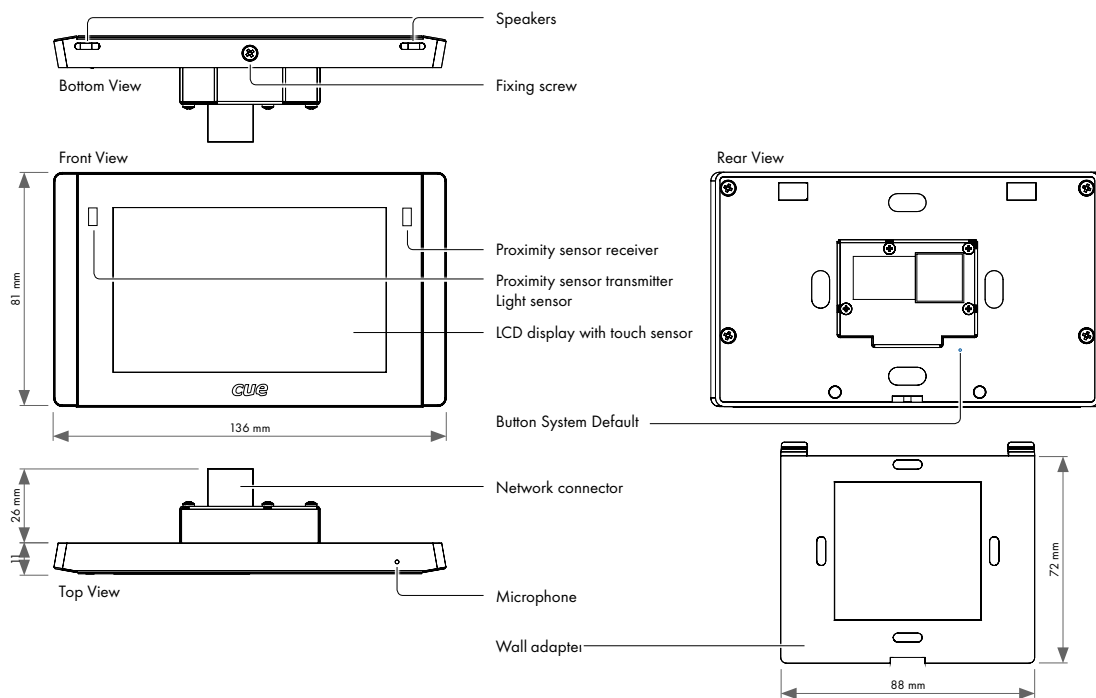

touchCUE-7-B

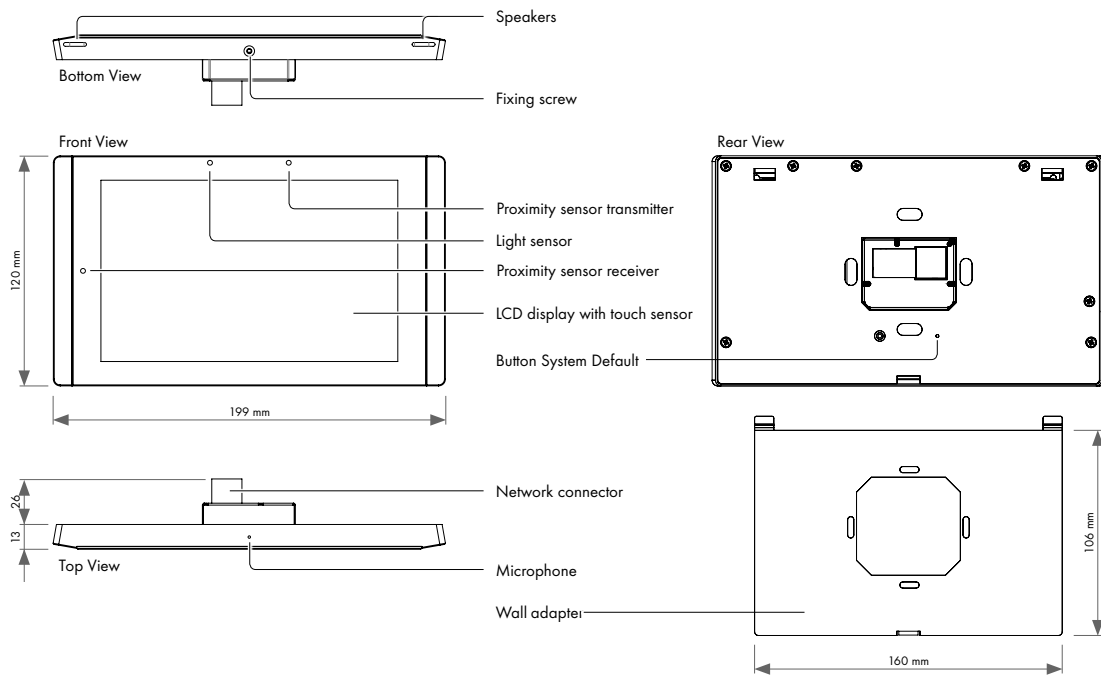

touchCUE-10-B

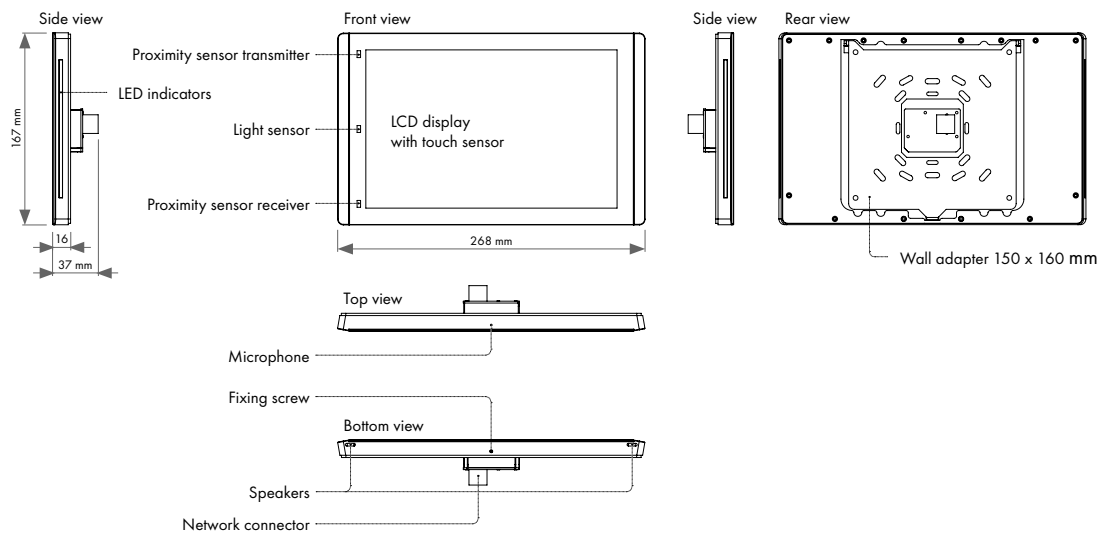

touchCUE-12-B

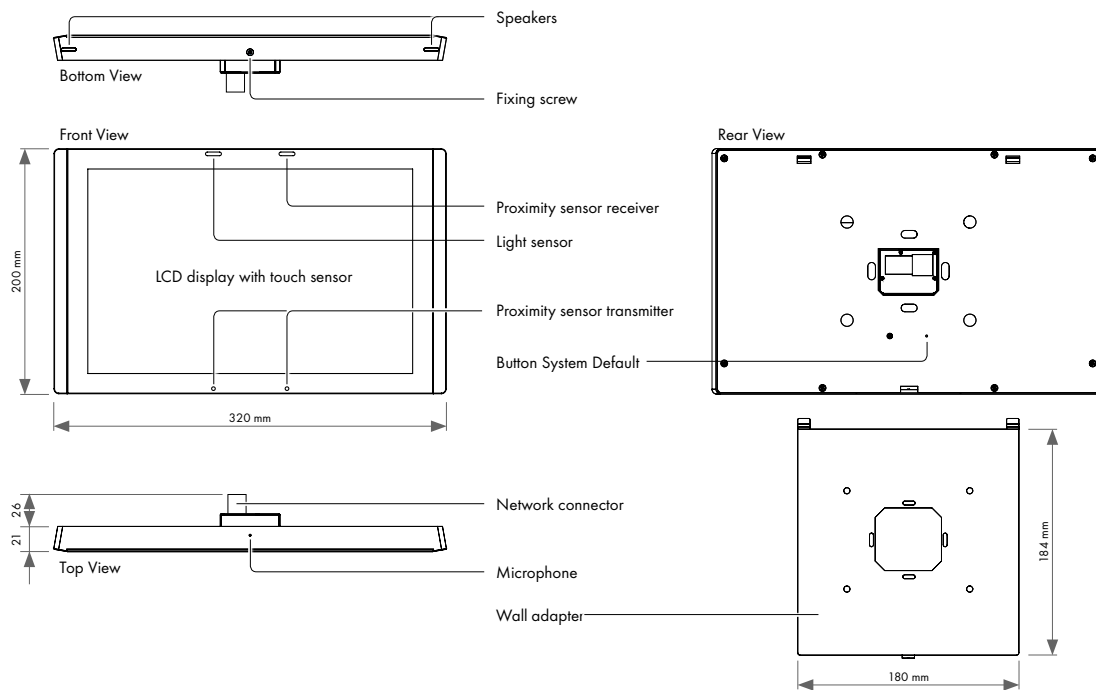

On-Wall Multisurface Models

touchCUE-7-M

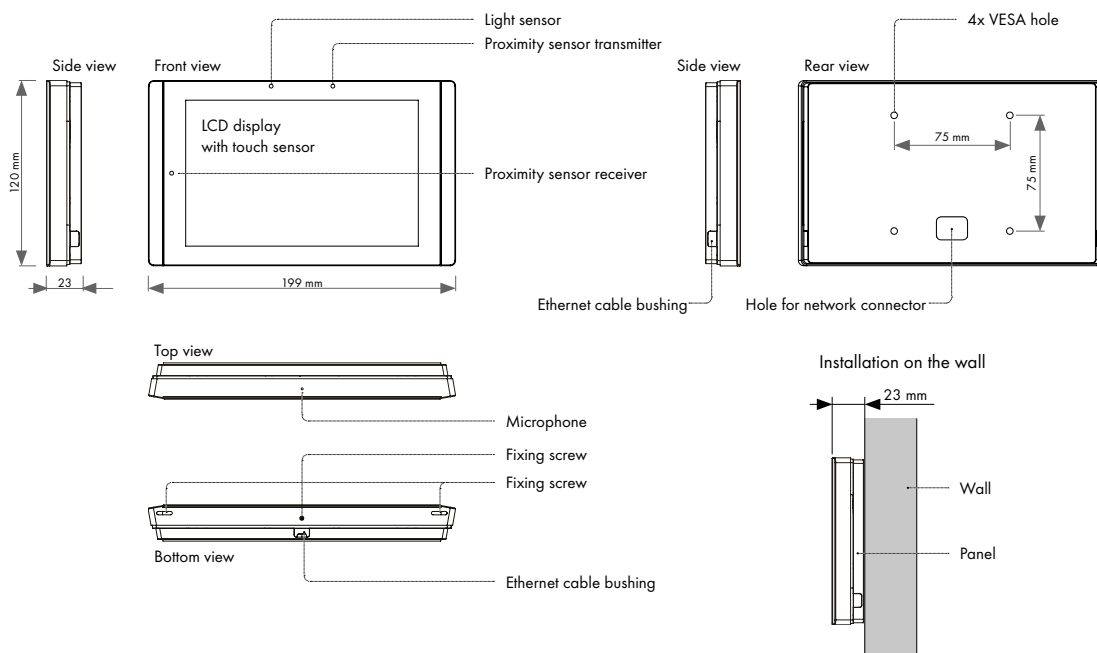

touchCUE-10-M

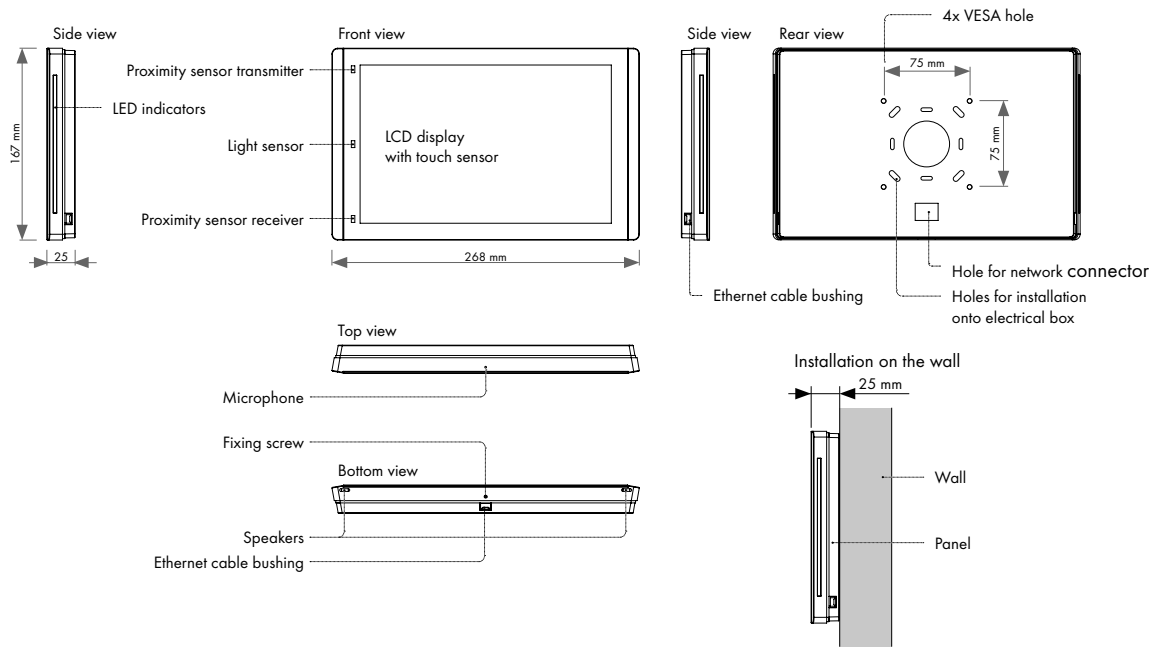

touchCUE-12-M

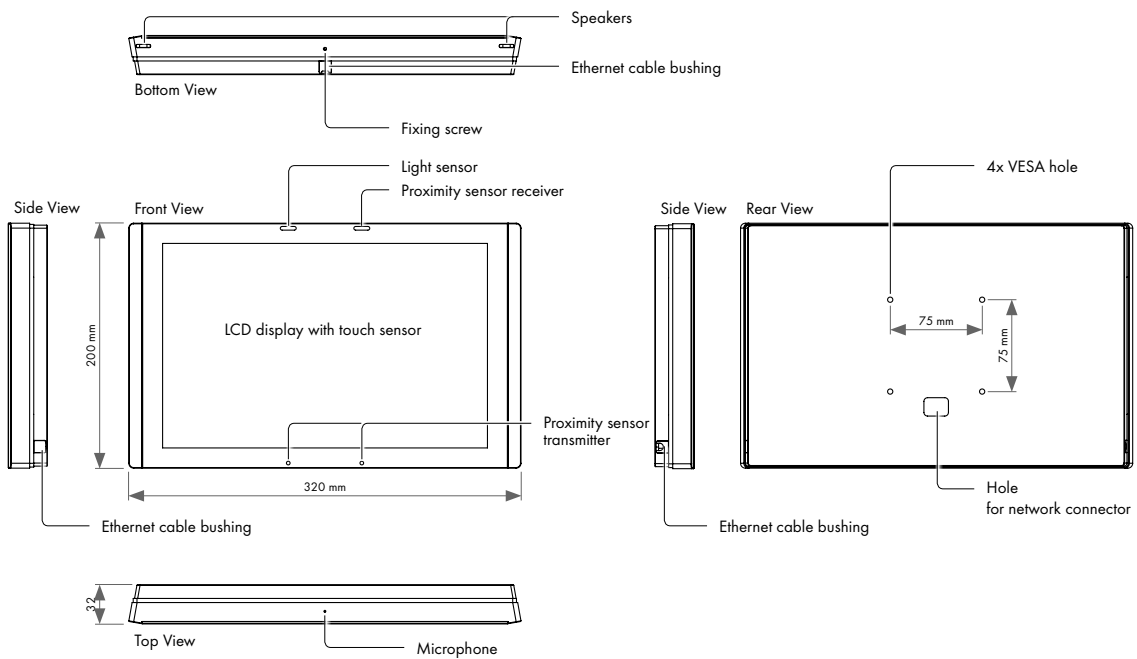

Part Description

Microphone

The microphone is prepared for future use. The functionality depends on a firmware version.

Proximity sensor

The Motion sensor resumes touch panel from Backlight Saver mode. This functionality can be enabled / disabled using On Screen Display or Admin Web.

Light Sensor

The Light Sensor automatically adjusts display backlight according ambient light level. This function has to be enabled using On Screen Display or Admin Web.

Side indicators

Two programmable RGB LED indicators are located on the left and right side of touch panel enclosure. Special command is available in XPL² programming language to control indicators.

For touchCUE-10, touchCUE-10-B and touchCUE-10-M only.

Touch-screen display

Touch-screen display with active matrix color LCD and resistive membrane touch overlay.

Speakers

The built-in stereo speakers allows to play sounds stored in the touch panels.

System Default Button

When pressed the factory default function is performed. For factory default values see chapter Factory Default and System Default. A thin screwdriver is needed for press of this button.

Network Connector

The 10/100 BaseT LAN is a standard network connection equipped with Power over Ethernet using RJ-45 connector. For more details see chapter Connection.

MOUNTING

Tabletop Models

Desktop models can be placed on any flat surface. Installation steps are as follows

1. Don't forget to prepare proper bushing for the cable including standard connector. A minimum diameter of the bushing for Ethernet connector is approx. 20 mm.
2. Install the network cable as described on the following picture and connect the network connector.

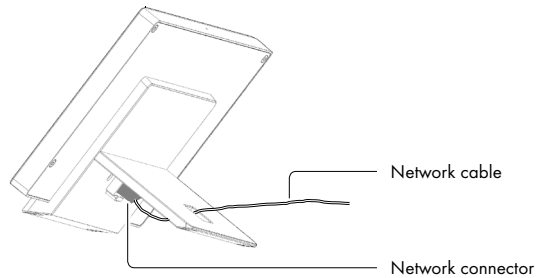

3. Place the touch panel on a table.

Built-In Models

All built-in models are compatible with standard European/UK electrical wall boxes as described in the following picture.

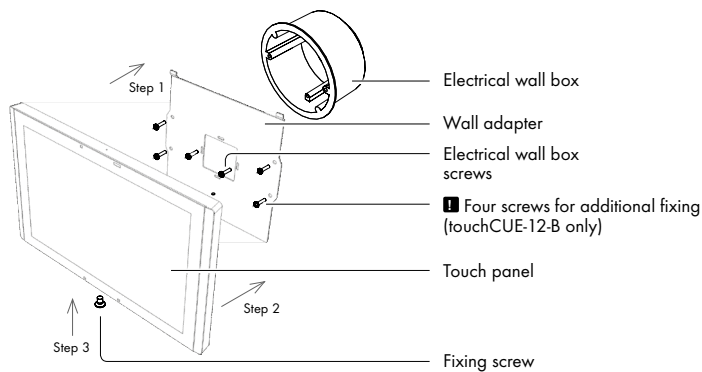

Installation steps are as follows

1. Install wall adapter on the electrical wall box and provide additional fixing by four delivered screws and fasteners.
 - Additional fixing is strictly recommended for touchCUE-12-B.
 - Use delivered screws or keep maximum screw dimensions as described below.

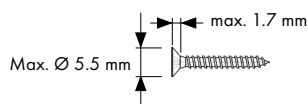

2. Connect network cable and put the touch panel on the wall adapter.

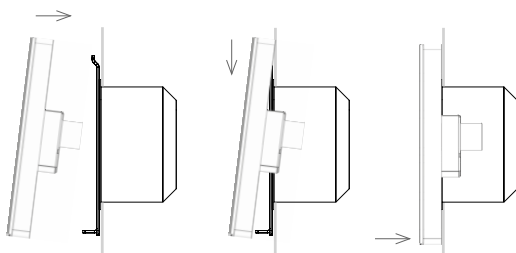

3. Carefully tighten the fixing screw to fix touch panel on the wall.

On-Wall Multisurface Models

Using Adhesive Foil

This method is typically use for glass wall installation.

Step 1



Degrease wall (typically glass) surface with alcohol and left it completely dry.

Step 2



Sign top of foil in height 1 560 mm from the floor. It is for recommended height 1 500 mm from floor to center of the panel.

Step 3



Partly remove protective film from adhesive foil and cut it.

Step 4



Use vertical ruler or level to adjust correct foil vertical position. Put foil on the wall with the protective film (not with adhesive part) to the ruler or level.

Step 5



Stick the adhesive part of foil using delivered squeegee.

Step 6



Partially remove the protective film and stick the rest of the foil using a squeegee.

Step 7



Squeegee lengthwise from the center outwards with overlapping strokes.

Step 8



Loosen the fixing screw using delivered Allen key - ① and remove back cover of the panel - ②, ③.

Step 9

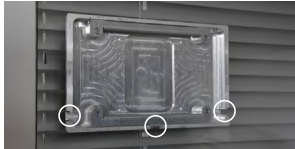

Position of back cover must be oriented as displayed above - cable bushings are left, right and bellow side oriented.

Step 10



Degrease foil installed on the wall and left it completely dry. Remove protective film from the adhesive tape (installed on the rear side of the back cover) and carefully attach it on the foil installed on the wall.

Step 11



Install cable to the selected bushing and install appropriate cable cover. Cable length inside is 25 cm. Covers for flat and round cables as well as for unused bushings are delivered. Covers are fixed with adhesive tape.

Step 12



Connect Ethernet cable to the panel and put the panel on the back cover - ①, ②. Carefully tighten the fixing screw to fix panel on the back cover - ③.

Using Screws

Step 1



Loosen the fixing screw using delivered Allen key - ① and remove back cover of the panel - ②, ③.

Step 2

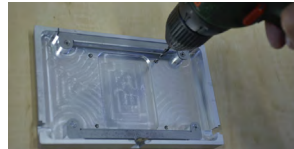

Drill four holes for screws. Use indicated pre-drilled positions.

Step 3

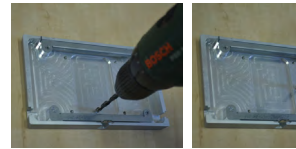

Drill the hole for cable. Hole diameter is 6 mm for cable without connector, 15 mm for cable with connector. Restricted area for drilling the hole is described on the drawing.

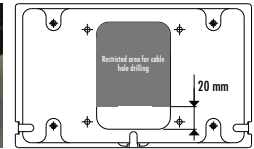

Step 4



Install cable to appropriate position on the wall regarding restricted area described in previous step. Recommended cable length from the wall is 25 cm. Recommended height from floor to center of the panel is 1 500 mm.

Step 5

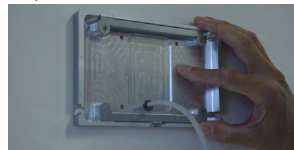

Install cable to the cable hole and put back cover on the wall. Position of back cover must be oriented as displayed above - cable bushings are left, right and bellow side oriented.

Step 6



Fix back cover on the wall using appropriate screws depending on the wall material.

Step 7

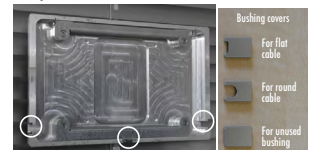

Install covers for unused bushings as described above. Covers are fixed with adhesive tape.

Step 8



Connect Ethernet cable to the panel and put the panel on the back cover - ①, ②. Carefully tighten the fixing screw to fix panel on the back

CLEANING THE TOUCH PANEL

You should clean the touch panel screen overlay after each day's use.

Materials required are

1. Two clean, soft texture cloths (cotton).
2. Spray bottle of cleaning solution without alcohol (window cleaner).
3. Aluminium parts should be cleaned using a special cleaning solution.

Steps are

1. Turn the touch panel off.
2. Spray a small amount of the cleaning solution onto one of the cloths.
3. Clean the touch panel overlay with the damp cloth.
4. Wipe the touch panel overlay with the dry cloth.

CONNECTION

Ethernet

The 10/100 BaseT LAN is a standard network connection 10/100 BaseT LAN using RJ-45 connector. There is no auto sense, which means it does not recognize straight through cable to cross-over cable. For the direct PC connection it is necessary to use cross-over cable; for the connection to Ethernet switch straight through cable. The length of the Ethernet cable connecting touch panel to the network must not exceed 100 meters.

Power over Ethernet is fully compatible with

- IEEE 802.3af (PoE) standard for 4.3" and 7" models
- IEEE 802.3at (PoE Plus) standard for 12" models.

Power over Ethernet integrates data and power on the same wires. It keeps the structured cabling safe and does not interfere with concurrent network operation.

Power over Ethernet needs compatible Ethernet switches or injectors currently available by most leading network equipment vendors.

Ethernet without PoE Infrastructure

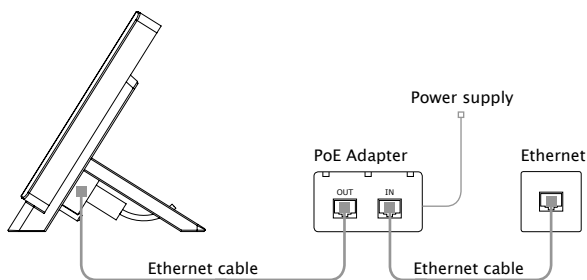

Ethernet with PoE Infrastructure

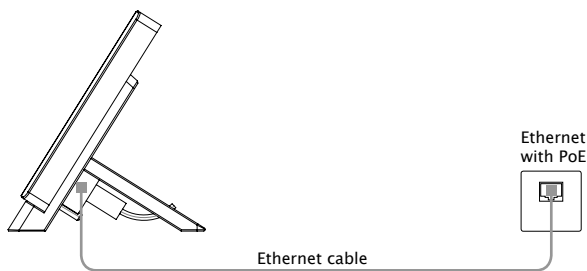

Connector pin out

RJ-45	Pin	Signal	Cat5 Cable Color
	1	TX_D1+ and PoE	White / Orange
	2	TX_D1- and PoE	Orange
	3	RX_D2+ and PoE	White / Green
	4	PoE +/- 48 V	Blue
	5		White / Blue
	6	RX-D2- and PoE	Green
	7	PoE Common	White / Brown
	8		Brown

Direct PC Connection

All touch panel models are equipped with PoE power supply (4.3" and 7" models) or PoE+ power supply (12" models). That means one Cat cable is used for power supply and for data.

Make sure you use

- PoE Adapter for 4.3" and 7" models
- PoE+ Adapter for 12" models.

Connection steps are as follows

1. Attach one end of a RJ-45 Ethernet straight-through cable to the CUEnet (LAN) port on touch panel and attach the other end of this cable to OUT port of PoE (PoE+) Adapter.
2. Attach one end of a RJ-45 Ethernet straight-through cable to the IN port of PoE (PoE+) Adapter and attach the other end of this cable to LAN port of your computer.
3. Attach power supply to the PoE (PoE+) adapter.

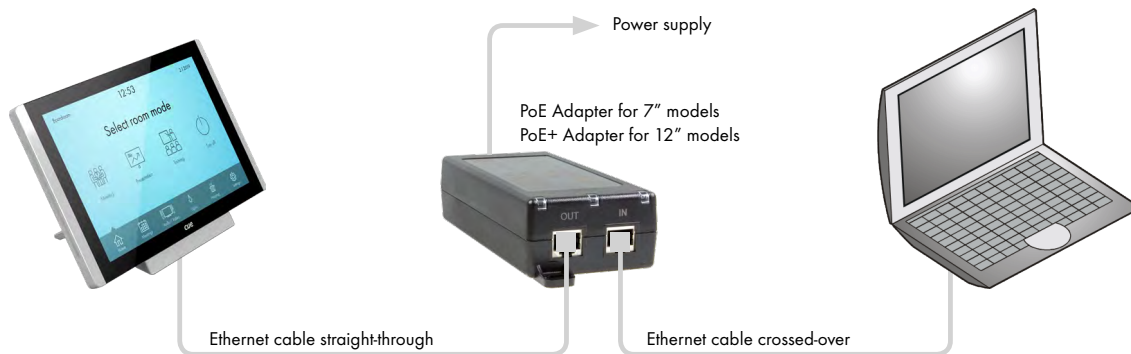

WINDOWS LOCAL NETWORK SETTINGS

For Windows 7 steps are

1. Start Windows 7.
2. Click Start.
3. Enter **ncpa.cpl** to the Search Box and press Enter. Following window is displayed.

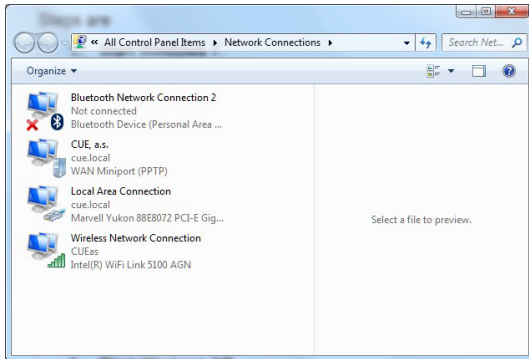

For Windows XP steps are

1. Start Windows XP.
2. Click Start, then click Control Panel choose the option to switch to Classic View.
3. Double-click Network Connections.

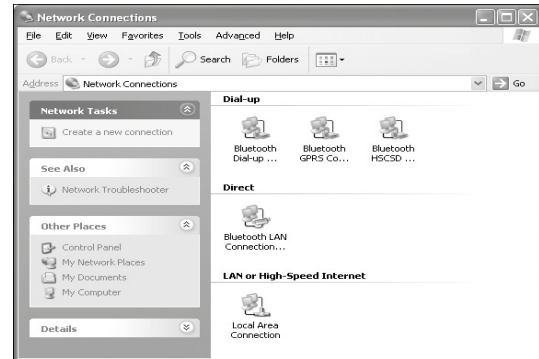

Following steps are

1. Right-click on network adapter used for connection with touch panel and then right-click and select Properties.
2. Select Internet Protocol (TCP/IP) and click Properties button.
3. Select Use the following IP address option. Set IP address to 192.168.1.1 (or other address different from 192.168.1.127 and from 192.168.1.128) and Subnet mask to 255.255.255.0. Leave other options unchanged and click OK.

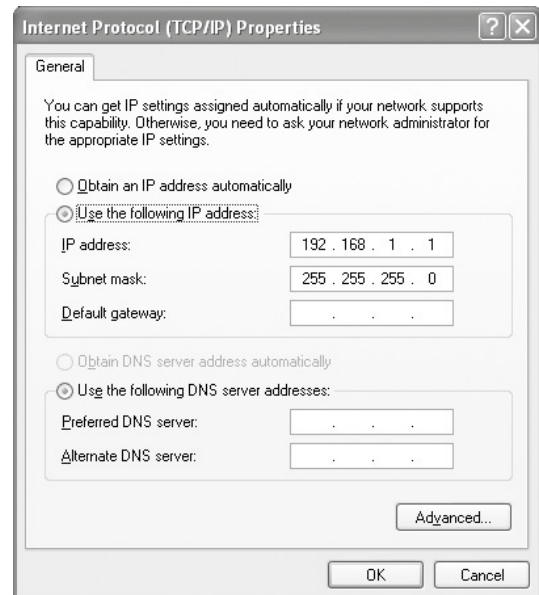
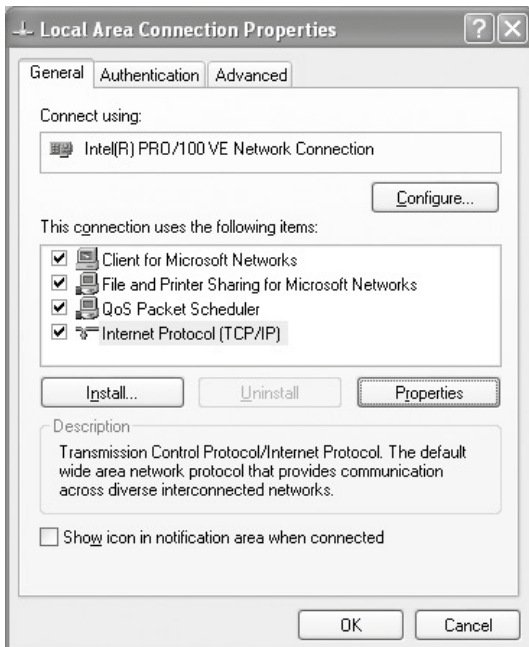

USER APPLICATION DOWNLOAD

Overview

User control application is dedicated to control and it is programmed by Cue Visual Composer programming tools.

Using Cue Visual Composer

Steps are

1. Connect touch panel to your computer as described in chapter PC Connection.
2. Run Cue Visual Composer on your PC.
3. Open appropriate project in Cue Visual Composer. It's necessary to have appropriated touch panel properly inserted and configured.
4. Use tool bar button **Final** to open Upload and Export Application dialog box.

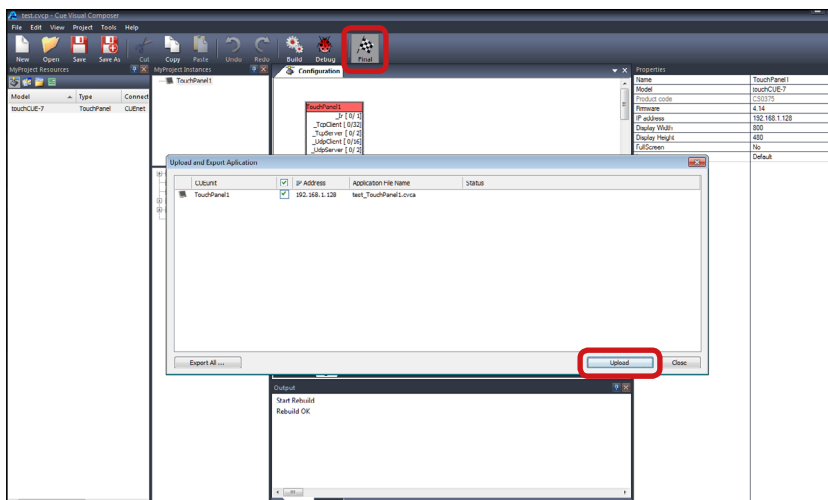

5. Be sure your touch panel is checked.
6. Use button **Upload** to start application upload.
7. If touch panel firmware isn't actual it will be uploaded automatically first and then application upload will be finished.

Using Admin Web

Steps are

1. Connect touch panel to your computer as described in chapter PC Connection.
2. Run Cue Visual Composer on your PC.
3. Open appropriate project in Cue Visual Composer. It's necessary to have appropriated touch panel properly inserted and configured.
4. Use tool bar button **Final** to open Upload and Export Application dialog box.

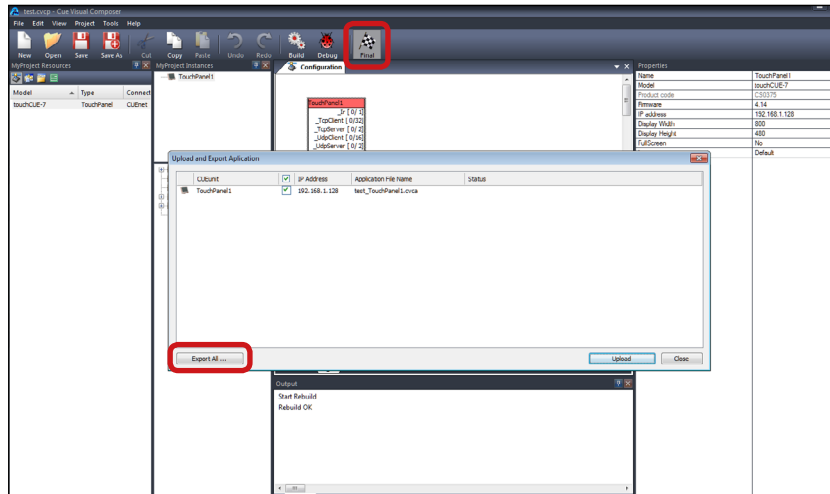

5. Be sure your touch panel is checked.
6. Use button **Export All...** to export application and store it in file *.cvca.
7. Run the Internet browser on your PC and type in the same touch panel IP address as you see in Cue Visual Composer project, window Properties / IP address.
8. Go to page **System** and check current firmware version. In case there is no actual firmware version in touch panel, upload firmware version that corresponds to firmware version in the Cue Visual Composer project..
9. Go to page **Applications** and upload application file *.cvca.
10. Start uploaded application using button **Start**.

FACTORY DEFAULT AND SYSTEM DEFAULT

Every device shipped from the factory is set according to table below, Factory Default column.

When pressed System Default button, the system default function is performed according to table below, System Default column. The main purpose of this functionality is to regain connection to touch panel with lost password or unknown IP settings.

		Factory Default		System Default
Configuration	Identification	Magic name	touchCUE-x-x_CSxxxx.Rxx.xxxx	Not changed
	IP settings	DHCP	On	On
		IP address (alternate)	192.168.1.128	192.168.1.128
		Subnet mask	255.255.255.0	255.255.255.0
		Default gateway	192.168.1.1	192.168.1.1
DNS	Primary DNS server	Empty	Not changed	
	Secondary DNS server	Empty	Not changed	
Date and time	Date and Time	Day, month, year	Real	Not changed
		Hour, minute, second	Real	Not changed
		Time zone	(GMT+1:00 CET/CEST Belgrade, ..., Prague)	Not changed
	Internet clock	Use Internet clock	Not	Not changed
Primary NTP server		Empty	Not changed	
Secondary NTP server		Empty	Not changed	
Applications			Empty	Not changed
File storage			Empty	Not changed
System	Firmware		Current version	Not changed
Password			Empty	Empty

ON SCREEN DISPLAY

Access On Screen Display



The Startup Menu is activated if no application is running.

Application button starts downloaded application.

On Screen Display button launches menu described below.

Settings

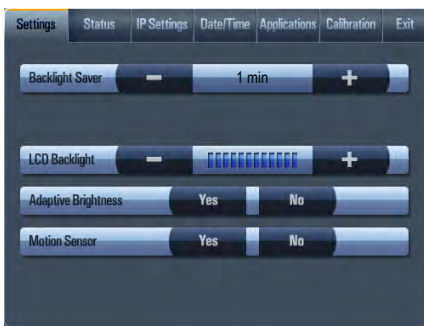

The Backlight Saver will switch off automatically display backlight. Time in minutes can be set by buttons - and +. Time set to 0 means that Backlight Saver is disabled.

LCD Backlight sets display backlight level.

If Adaptive Brightness is switched to Yes, the light sensor automatically adjusts display backlight according ambient light level.

If Motion Sensor is switched to Yes the Motion Sensor resumes touch panel from Backlight Saver mode automatically.

Status



This page shows current status of the touch panel.

IP Settings



This page is used for setting the communication parameters for your touch panel. The touch panel uses standard internet protocol (IP) communication parameters. Certain parameters can be reset by the user. On start up, this page will display current IP address. Carefully note this addressing information (and any changes you elect to make to the IP address, subnet mask, or default gateway). You can also set touch panel to obtain IP address automatically from DHCP server. For it select Yes in the field Use DHCP. IP address (or Magic name, see chapter Admin Web) must be entered into the Cue Visual Composer program written for your specific application. For control systems with more than one unit, a unique IP address must be given to each CUEunit. For setting please select appropriate field using Edit button and then use numeric keypad. Be sure to click the Apply button for any changes to become effective.

Date/Time

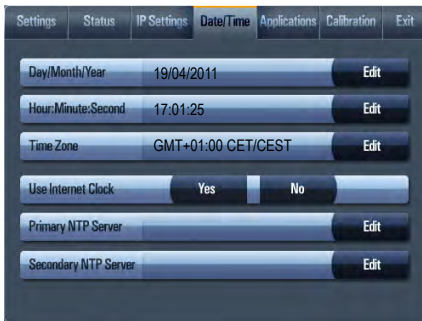

This page is used for setting Date/Time parameters.

The current date and time can be set. For setting please select appropriate field using Edit button and then use numeric keypad.

The time zone box can be selected to enter from the list activated by button Edit.

Rest of the page is used for synchronization of the CUEunit's date and time with an internet clock. Select Yes for Use Internet clock. Next, enter the IP addresses (or complete address name) of the primary and secondary NTP servers.

Applications

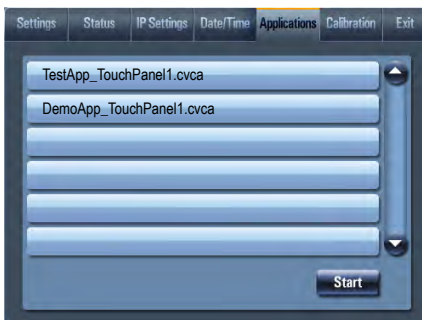

This screen is used for selection, start and stop of uploaded applications. All uploaded applications are listed on this page.

Select application and press button Start. A "running flag" denotes the active application. Active application starts automatically after switch on the unit. The running application can be stopped via the Stop button.

Files are uploaded from a personal computer to the touch panel using Cue Visual Composer software or using Admin Web.

Exit

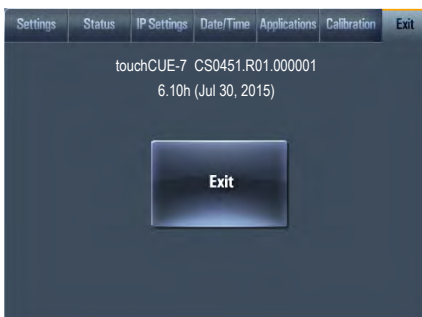

Closes the On Screen Display.

On this page the product name, product code and current firmware version are displayed.

ADMIN WEB

Access Admin Web

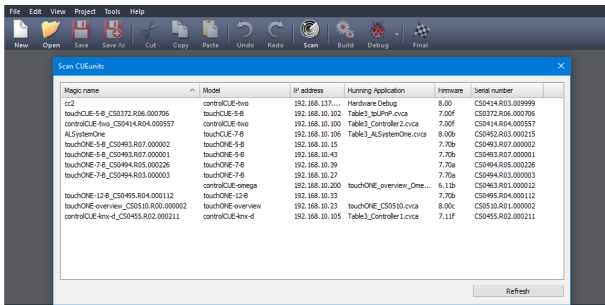

Run the Internet browser on your PC and type in the touch panel IP address.

Run the Internet browser on your PC and type in the touch panel IP address.

IP address is obtained from DHCP server by (factory default or it is 192.168.1.128, if DHCP is not available on the network. The default password is empty.

You can find CUEunits and their IP addresses on the network with Cue Visual Composer / Tools / Scan CUEunits... You can open Internet browser with admin web of given unit by doubleclick on the line with this unit.

Login

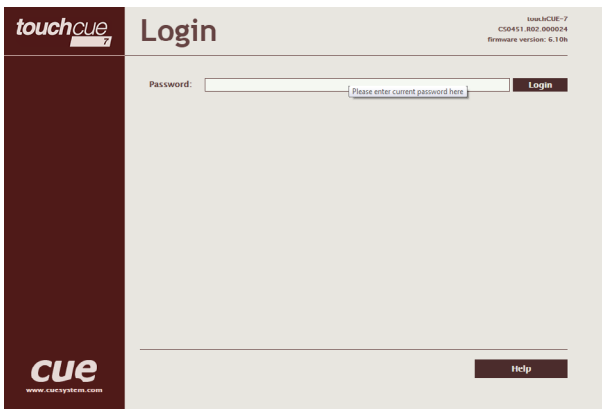

This screen isn't displayed if password is empty (factory default status).

If password isn't empty, you have to login at first for operating with your CUEunit via these web pages.

Enter your password into the Password box and click the Login button to enter the CUEunit web pages.

Remember that the password is case sensitive. For changing your password use the Password menu after you are logged in.

Configuration

Identification

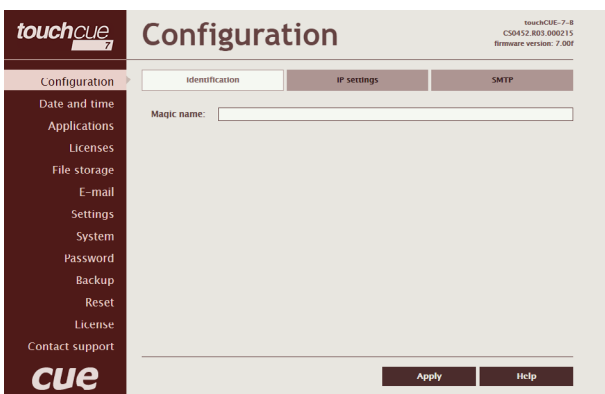

Every CUEunit can be identified by a unique Magic name. Magic names are most useful in applications requiring more than one CUEunit or when CUEunit obtain IP address from DHCP server. This enables programmers and installers to reference CUEunits with logical, user friendly names, like "boardroom," "lobby," etc.

To set the CUEunit identity, enter the unique name you wish to use in the Magic name box.

Be sure to click the Apply button for any changes to become effective!

IP Settings

The screenshot shows the 'Configuration' page for touchCUE-7. The 'IP settings' tab is selected. The page displays various network parameters and their current values, along with input fields for modification. A sidebar on the left contains navigation links for different configuration sections. At the bottom right, there are 'Apply' and 'Help' buttons.

Parameter	Current Value
Physical address (MAC)	00:1E:C0:FE:57:84
Current IP address	192.168.10.106
Current subnet mask	255.255.255.0
Current default gateway	192.168.10.1
Current primary DNS server	192.168.10.1
Current secondary DNS server	

Use DHCP to obtain IP address:

IP address:

Subnet mask:

Default gateway:

Primary DNS server:

Secondary DNS server:

This page is used for establishing the communication parameters for your CUEunit.

The CUEunit uses standard internet protocol (IP) communication parameters. Certain parameters can be reset by the user. On start up, this page will display the CUEunit's given Physical address (MAC), Current IP address, Current primary DNS server and Current secondary DNS Server. Carefully note this address information (and any changes you make to the IP address, subnet mask, default gateway or primary and secondary DNS server). You can also set CUEunit to obtain IP address automatically from DHCP server. For it check the checkbox Use DHCP to obtain IP address. IP address or Magic name must be entered into the Cue Visual Composer program written for your specific application. For control systems with more than one CUEunits, a unique IP address must be given to each CUEunit.

Some control systems are "stand alone" and not part of a larger network. For such "stand alone" systems, the Magic name is optional. However, for control systems that are connected to a larger network, please obtain the Host name from the network administrator, and enter it into the Magic name box.

Be sure to click the Apply button for any changes to become effective!

SMTP

The screenshot shows the 'Configuration' page for touchCUE-7, with the 'SMTP' tab selected. The page is used for configuring an outgoing mail server. It includes fields for the server name and port, and an authentication section with a dropdown menu for the type and fields for username and password. A sidebar on the left provides navigation options. 'Apply' and 'Help' buttons are located at the bottom right.

Outgoing mail server (SMTP)

Name:

Port:

Authentication

Type:

Username:

Password:

This page is used for setting parameters of SMTP server. Set a name or an address and the port of your SMTP server.

The SMTP server and port are used by the XPL2 commands EmailSend and PresetEmailSend.

Be sure to click the Apply button for any changes to become effective!

Date and Time

Current date and time

The screenshot shows the 'Date and time' configuration page with the 'Current date and time' tab selected. The current time is 01.01.2003 00:37:37. The date is set to 01/01/2003 and the time to 00:37:37. There are 'Apply' and 'Help' buttons at the bottom right.

This page is used for setting the time clock on your CUEunit. The current date, time, and time zone are shown on the Current time line.

The applicable boxes can be selected to enter changes to the

- date: day/month/year,
- time: hour/minute/second.

Be sure to click the Apply button for any changes to become effective!

Time zone

The screenshot shows the 'Date and time' configuration page with the 'Time zone' tab selected. The current time is 01.01.2003 00:49:47. The time zone is set to (UTC) Coordinated Universal Time. A note states: 'Note: Daylight saving time is applied automatically (if daylight saving time is observed)'. There are 'Apply' and 'Help' buttons at the bottom right.

This page is used for setting the time zone on your CUEunit. The current date, time, and time zone, are shown on the Current time line. The time zone box can be selected to enter changes to the Time zone.

Be sure to click the Apply button for any changes to become effective!

Internet clock

The screenshot shows the 'Date and time' configuration page with the 'Internet clock' tab selected. There is a checkbox for 'Use Internet clock'. Below it are input fields for 'Primary NTP server' and 'Secondary NTP server'. A note states: 'Note: The Public NTP Time Server Lists are [here](#).' There are 'Apply' and 'Help' buttons at the bottom right.

This page is used for synchronization of the CUEunit's date and time with an internet clock. Begin by selecting the check box for Use Internet clock. Next, enter the IP addresses (or complete address name) of the primary and secondary NTP servers. Use the Primary NTP server and Secondary NTP server boxes for this purpose.

Be sure to click the Apply button for any changes to the internet clock to become effective!

Applications

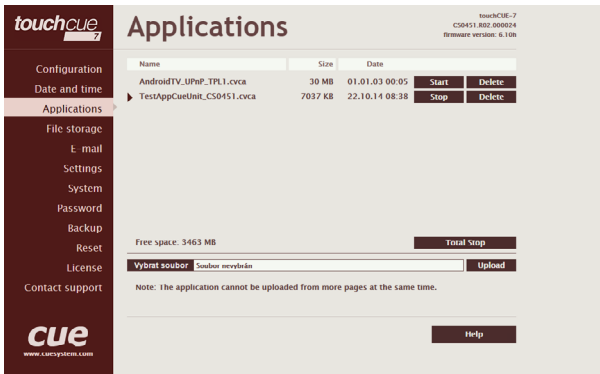

This page is used for uploading compiled Cue Visual Composer programs to your CUEunit.

All uploaded applications are listed on this page, along with their file properties: file name/file size/date. The CUEunit has a generous memory; unused free space is shown at the bottom of this page. CUEunit also permits other service functions like deleting files, downloading programs back to a personal computer, and starting/stopping specific applications.

A “running flag” denotes the active application. The running application can be stopped via the Start/Stop button. Likewise, a stopped application can be restarted with the Start/Stop button.

Files are uploaded from a personal computer to the CUEunit by selecting the desired application program, and clicking the Upload button. Files are downloaded from the CUEunit to a personal computer by clicking the File name. Files are easily deleted with the Delete button. The button Total stop stops a running application. This application will not be automatically started after reset.

File Storage

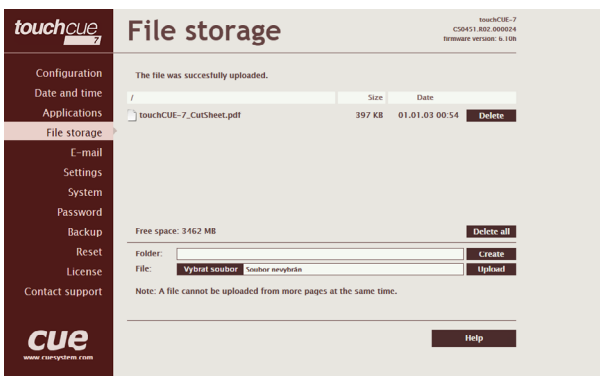

The CUEunit’s generous memory can be used as an auxiliary file storage device. This is helpful for storing presets, in archiving electronic manuals, pdf files, and other support documentation. File storage is managed via the file storage page.

A list of existing files, folders, and their properties is shown. To delete a file or a folder, click the Delete button on the corresponding line. To delete all files and folders from the current folder, click the Delete All button.

To create a new folder, enter a name for the new folder, and click the Create button. To upload a file, select the desired file, and click the Upload button.

Note: Files are automatically compressed for the CUEunit’s internal file system. Accordingly, the size of your uncompressed file before storing may not match the decrease of free space shown on the CUEunit.

E-mail

This page is used for setting parameters of e-mail parameters and recipients addresses.

The SMTP server must be set. See the Configuration/SMTP setting.

The sender Name and E-mail are addresses of your CUEunit. The sender Name and E-mail are used by the XPL2 commands EmailSend and PresetEmailSend.

The recipient Names and E-mails are addresses of recipients, where e-mails will be sent using the XPL2 command PresetEmailSend.

Settings

Settings

On this page some display features can be set.

The Backlight Saver will switch off automatically display backlight. Time in minutes can be set. Time set to 0 means that Backlight Saver is disabled.

LCD Backlight sets display backlight level.

If Adaptive Brightness is switched to Yes, the light sensor automatically adjusts display backlight according ambient light level.

If Motion Sensor is switched to Yes the Motion Sensor resumes touch panel from Backlight Saver mode automatically.

On Screen Display

This page serves for setting of On Screen Display functionality.

Type of activation is defined here as well as mode of the On Screen Display. In Advanced mode all functions are available, Basic mode is more safety (for example network settings can't be changed).

In addition some settings done by On Screen Display can be enabled or disabled.

System

Firmware

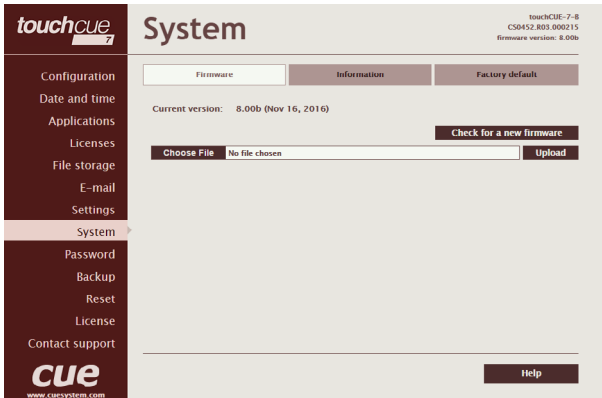

This page is used for updating the CUEunit firmware. The Current version of firmware is shown. To upload new firmware, select the desired version, and click the Upload button.

Information

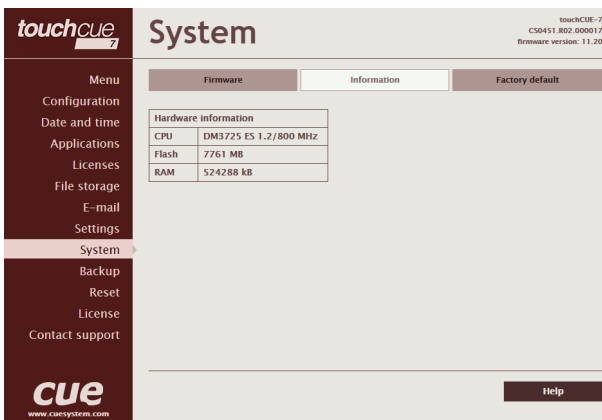

The page shows basic information about your CUEunit's hardware. The CPU type, CPU frequency, and the flash and RAM memory sizes are shown.

Factory default

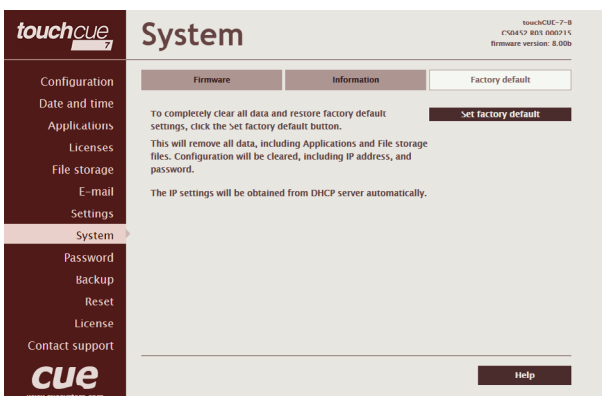

To completely clear all data and restore factory default settings, click the Set factory default button.

This will remove all data, including Applications and File storage files. Configuration will be cleared, including IP address, password, and touch-screen calibration values. DHCP will be enabled and IP address will be get from DHCP server.

Password

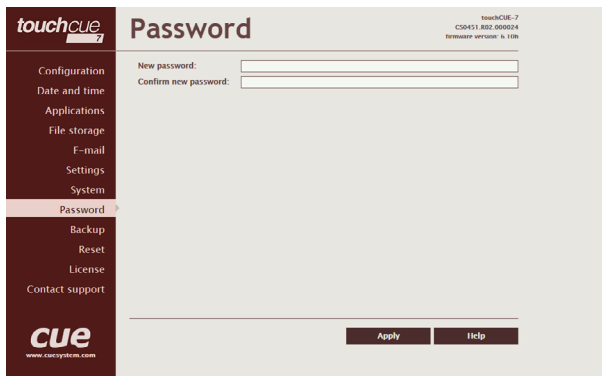

A case sensitive password is necessary to login to the admin web pages. Set a new password via the New password box. You must reenter the password in the Confirm new password box. An error message will appear if the confirmation does not match, in which case you should reenter your password again in both boxes.

Finally, the new password is implemented by clicking the Apply button.

Backup

Backup

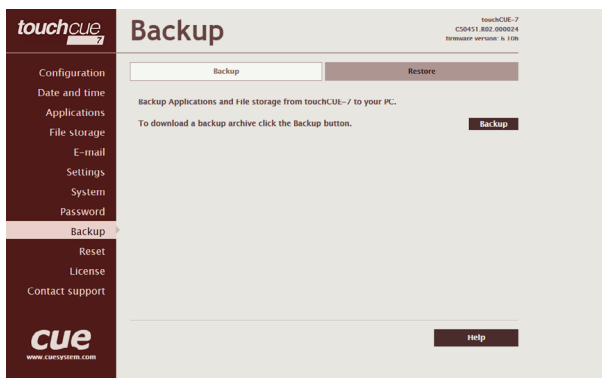

The page is used for the backup applications, files and folders. The Backup copies all Applications, Application data, File storage and Web storage to the one archive. This archive is saved to the PC. To start the backup process, click the Backup button.

Note: To see the backed-up/restored applications, click the Applications menu. To see backed-up/restored files and folders, click the File Storage menu. The page is used for the backup of all applications, files and folders.

Note: To see the backed-up/restored applications, click the Applications menu. To see backed-up/restored files and folders, click the File Storage menu.

Restore

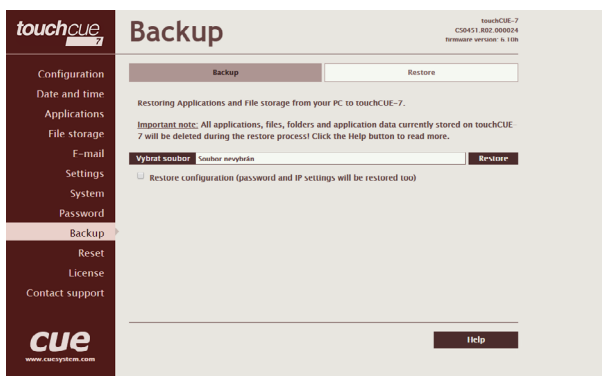

READ ALL IMPORTANT NOTES THAT FOLLOW BEFORE USING THIS OPERATION!

The page is used for the restoring of all applications, files and folders. Restore copies of all applications, files, and folders from a backup archive on the PC to their corresponding locations on the CUEunit. To start the restore process, select the desired backup archive, then click the Restore button. The restore process can take up to 10 minutes, depending on the size of the files being restored. If you want CUEunit's settings will be restored too, check the "Restore configuration" box. The CUEunit's settings are accessible via the Configuration, Date and time and Password menus.

Important notes

- Actual password and IP settings will be restored too. The restore process takes from 1 to 10 minutes. It depends on the sizes of the restored files.
- When restoring files, the running application will be stopped and all applications, files, and folders currently stored in the CUEunit will be deleted! If you want to retain them, use the Backup command before the Restore command.
- To see the backed-up/restored applications, click the Applications menu. To see backed-up/restored files and folders, click the File Storage menu.

Reset

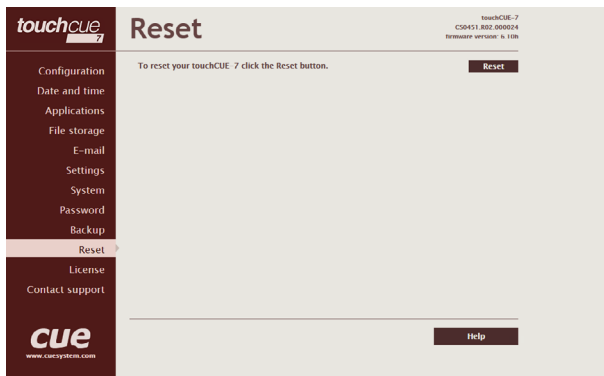

To restart your CUEunit, click the Reset button.

License

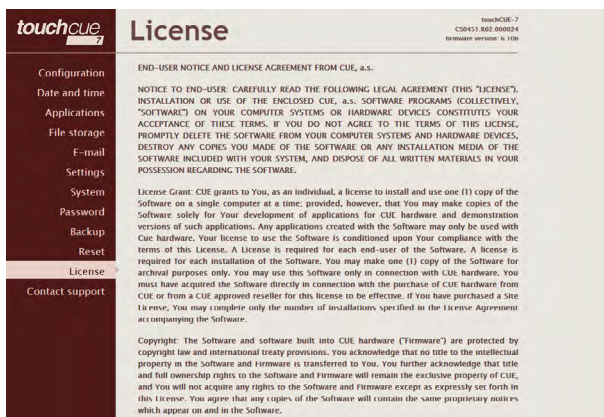

This page describes software license.

SOFTWARE AND FIRMWARE LICENSE

END-USER NOTICE AND LICENSE AGREEMENT FROM CUE, a.s.

NOTICE TO END-USER: CAREFULLY READ THE FOLLOWING LEGAL AGREEMENT (THIS "LICENSE").

INSTALLATION OR USE OF THE ENCLOSED CUE, a.s. SOFTWARE PROGRAMS (COLLECTIVELY, "SOFTWARE") ON YOUR COMPUTER SYSTEMS OR HARDWARE DEVICES CONSTITUTES YOUR ACCEPTANCE OF THESE TERMS. IF YOU DO NOT AGREE TO THE TERMS OF THIS LICENSE, PROMPTLY DELETE THE SOFTWARE FROM YOUR COMPUTER SYSTEMS AND HARDWARE DEVICES, DESTROY ANY COPIES YOU MADE OF THE SOFTWARE OR ANY INSTALLATION MEDIA OF THE SOFTWARE INCLUDED WITH YOUR SYSTEM, AND DISPOSE OF ALL WRITTEN MATERIALS IN YOUR POSSESSION REGARDING THE SOFTWARE.

License Grant: CUE grants to You, as an individual, a license to install and use one (1) copy of the Software on a single computer at a time; provided, however, that You may make copies of the Software solely for Your development of applications for CUE hardware and demonstration versions of such applications. Any applications created with the Software may only be used with Cue hardware. Your license to use the Software is conditioned upon Your compliance with the terms of this License. A License is required for each end-user of the Software. A license is required for each installation of the Software. You may make one (1) copy of the Software for archival purposes only. You may use this Software only in connection with CUE hardware. You must have acquired the Software directly in connection with the purchase of CUE hardware from CUE or from a CUE approved reseller for this license to be effective. If You have purchased a Site License, You may complete only the number of installations specified in the License Agreement accompanying the Software.

Copyright: The Software and software built into CUE hardware ("Firmware") are protected by copyright law and international treaty provisions. You acknowledge that no title to the intellectual property in the Software and Firmware is transferred to You. You further acknowledge that title and full ownership rights to the Software and Firmware will remain the exclusive property of CUE, and You will not acquire any rights to the Software and Firmware except as expressly set forth in this License. You agree that any copies of the Software will contain the same proprietary notices which appear on and in the Software.

Prohibited Uses: Without obtaining prior written permission from CUE, You may not (a.) use, copy, modify, alter, or transfer the Software or documentation except as expressly provided in this License; (b.) translate, disassemble, decompile, reverse program or otherwise reverse engineer the Software and Firmware; (c.) sublicense or lease the Software or its documentation (d.) use this Software with any hardware other than products produced by CUE or in connection with applications being developed for CUE hardware; or (e.) use the Software in a multi-user, network, or multiple computer environment or in a rental, time sharing or computer service business. Without prejudice to any other rights, CUE may terminate this License if You fail to comply with its terms and conditions. In such event, You must immediately destroy all copies of the Software.

AVC Video Restrictions: THIS PRODUCT IS LICENSED UNDER THE AVC PATENT PORTFOLIO LICENSE FOR THE PERSONAL USE OF A CONSUMER OR OTHER USES IN WHICH IT DOES NOT RECEIVE REMUNERATION TO (i) ENCODE VIDEO IN COMPLIANCE WITH THE AVC STANDARD ("AVC VIDEO") AND/OR (ii) DECODE AVC VIDEO THAT WAS ENCODED BY A CONSUMER ENGAGED IN A PERSONAL ACTIVITY AND/OR WAS OBTAINED FROM A VIDEO PROVIDER LICENSED TO PROVIDE AVC VIDEO. NO LICENSE IS GRANTED OR SHALL BE IMPLIED FOR ANY OTHER USE. ADDITIONAL INFORMATION MAY BE OBTAINED FROM MPEG LA, L.L.C. SEE <http://www.mpegla.com>.

No Other Warranties: CUE DOES NOT WARRANT THAT THE SOFTWARE AND FIRMWARE IS ERROR FREE. CUE DISCLAIMS ALL WARRANTIES WITH RESPECT TO THE SOFTWARE AND FIRMWARE, EITHER EXPRESS OR IMPLIED, INCLUDING BUT NOT LIMITED TO IMPLIED WARRANTIES OF MERCHANTABILITY, FITNESS FOR A PARTICULAR PURPOSE AND NON-INFRINGEMENT OF THIRD PARTY RIGHTS. SOME JURISDICTIONS DO NOT ALLOW THE EXCLUSION OF IMPLIED WARRANTIES OR LIMITATIONS OF HOW LONG AN IMPLIED WARRANTY MAY LAST, OR THE EXCLUSION OF LIMITATION OF INCIDENTAL DAMAGES, SO THE ABOVE LIMITATIONS OR EXCLUSIONS MAY NOT APPLY TO YOU. THIS WARRANTY GIVES YOU SPECIFIC LEGAL RIGHTS AND YOU MAY ALSO HAVE OTHER RIGHTS WHICH VARY FROM JURISDICTION TO JURISDICTION.

No Liability for Consequential Damages: IN NO EVENT SHALL CUE BE LIABLE TO YOU FOR ANY CONSEQUENTIAL, SPECIAL, INCIDENTAL, OR INDIRECT DAMAGES OF ANY KIND ARISING OUT OF THE PERFORMANCE OR USE OF THE SOFTWARE, EVEN IF CUE HAS BEEN ADVISED OF THE POSSIBILITY OF SUCH DAMAGES.

Label on Hardware: Use of this hardware and the software programs controlling this hardware is subject to the terms of the Software and Hardware License Agreements (the "License Agreements"). You should not use the software and hardware until you have read the License Agreements. By using the software and hardware, you signify that you have read the License Agreements and accept their terms. The "License Agreement" is available at www.cuesystem.com.

Trademark Notice: CUE and the CUE logo are trademarks of CUE, a.s. in the United States and in other countries.

cue

CUE, a.s.
K Nouzovu 6, 143 00 Praha 4, Czech Republic
www.cuesystem.com
support@cuesystem.com