

# Lux-Up

Embellissez votre écran !



ORIGINE  
FRANCE®  
GARANTIE

BVCert. 6164725

ERARD®

# Lux-Up™ 900M, 1050L, 1400L et 1400XL

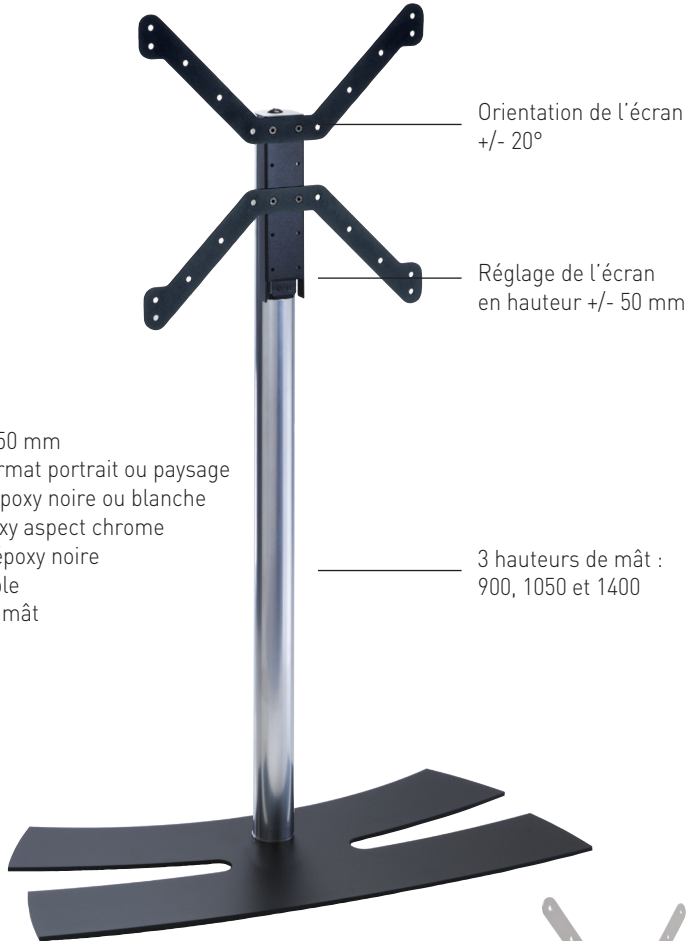

## CARACTÉRISTIQUES TECHNIQUES

- Réglage de l'écran en hauteur +/- 50 mm
- Possibilité de monter l'écran au format portrait ou paysage
- Socle en acier de 6 mm, peinture époxy noire ou blanche
- Mât diamètre 60 mm, peinture époxy aspect chrome
- Tête de fixation en acier, peinture époxy noire
- Livré démonté / Montage très simple
- Gestion des câbles incluse dans le mât

## OPTIONS

### Tablette Lux-Up™

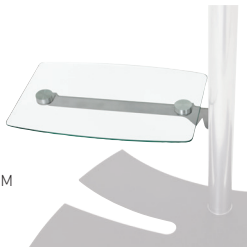

Ref. **038400** GENCOD 318528 038400 6

- Tablette additionnelle porte périphérique
- Positionnable à droite du mât
- Fixation à l'arrière du mât par 2 vis
- Tablette en verre trempé de 6 mm - Poids maxi 5 kg
- Dimensions utiles : 420 X 240 mm
- Dimensions hors tout : 420 X 270 mm

### Box-Up



Ref. **038401** GENCOD 318528 038401 3

- Support porte périphérique positionné derrière l'écran sur la tête de fixation du Lux-Up™
- Fixation par 2 vis
- Support en acier peinture époxy noire
- Maintien du périphérique par 3 sandows
- Reversible droite gauche

## Lux-Up™ 900M

Ref. **038042 - Noir** GENCOD 318528 038042 8

Ref. **038043 - Blanc** GENCOD 318528 038043 5

- Mât : 900 mm
- Socle : 705 X 319 mm
- VESA : 200 X 200

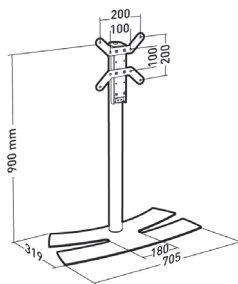

**M** 19"-32"  
48-81 cm



20 KG



+/- 20°



ÉPAISSEUR MAXI  
45 mm



VESA  
100-200

## Lux-Up™ 1050L

Ref. **038142 - Noir** GENCOD 318528 038142 5

Ref. **038143 - Blanc** GENCOD 318528 038143 2

- Mât : 1050 mm
- Socle : 865 X 440 mm
- VESA : 400 X 400

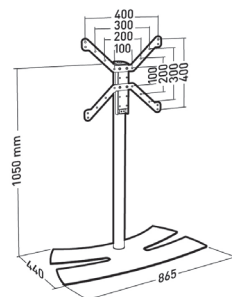

**L** 30"-55"  
76-140 cm



30 KG



+/- 20°



ÉPAISSEUR MAXI  
45 mm



VESA  
100-400

## Lux-Up™ 1400L

Ref. **038242 - Noir** GENCOD 318528 038242 2

Ref. **038243 - Blanc** GENCOD 318528 038243 9

- Mât : 1400 mm
- Socle : 935 X 440 mm
- VESA : 400 X 400

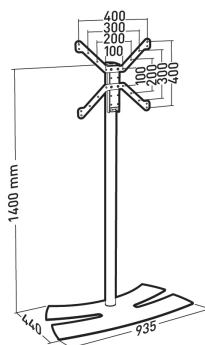

**L** 30"-55"  
76-140 cm



30 KG



+/- 20°



ÉPAISSEUR MAXI  
75 mm



VESA  
100-400

## Lux-Up™ 1400XL

Ref. **038342 - Noir** GENCOD 318528 038342 9

Ref. **038343 - Blanc** GENCOD 318528 038343 6

- Mât : 1400 mm
- Socle : 1054 X 507 mm
- VESA : 600 X 400

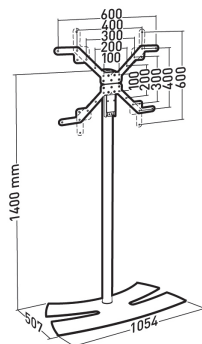

**XL** 40"-75"  
102-190cm



50 KG



+/- 20°



ÉPAISSEUR MAXI  
100 mm



VESA  
100-600X400

# Lux-Up™ 1600XL

Ref. **038442 - Noir** GENCOD 318528 038442 6

Ref. **038443 - Blanc** GENCOD 318528 038443 3

**XL** 40"-75"  
102-190cm



50 KG



ÉPAISSEUR MAXI  
100 mm

VESA  
100>600 X 400

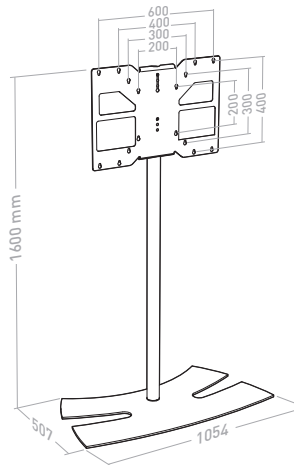
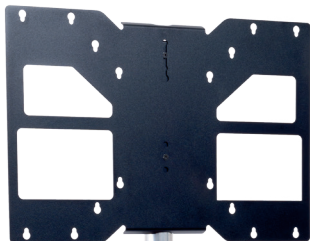

- Mât : 1600 mm
- Socle : 1054 X 507 mm
- VESA : 600 X 400

- Idéal pour les salles de réunion
- Possibilité de monter l'écran au format paysage ou portrait
- Ecran fixe
- Réglable en hauteur +/- 50 mm
- Socle en acier de 8 mm ; peinture époxy noire ou blanche
- Mât diamètre 60 mm ; peinture époxy aspect chrome



## ERARD®